

# 1.2.1(1)

## Add-on Programs

### For A.Y.: 2022-23



## **SRI SIVANI COLLEGE OF ENGINEERING**

(Under the Management of Sri Sivani Educational Society, Srikakulam)  
(Approved by AICTE, New Delhi and Affiliated to JNTUGV, Vizianagaram-CC-W6  
UGC Recognition under 2(f) & 12(B), ISO 9001:2015 Certified)  
NH-16, Chilakapalem Jn., Srikakulam Dist. Andhra Pradesh -532410



# SRI SIVANI COLLEGE OF ENGINEERING

(Under the Management of Sri Sivani Educational Society, Srikakulam)  
(Approved by AICTE, New Delhi and Affiliated to JNTUGV, Vizianagaram-CC-W6,  
UGC Recognition under 2(f) & 12(B), ISO 9001:2015 Certified)  
NH-16, Chilakapalem Jn., Srikakulam Dist. Andhra Pradesh -532410

## LIST OF ADD-ON/CERTIFICATE PROGRAMS

ACADEMIC YEAR: 2022-23

S.NO	Name of the Program	Duration	Number of Participants
1	A Two-Week Add-On program on Computer Vision and Image processing	12.09.2022 to 24.09.2022	50
2	A Two-Week Add-On program on Web Designing & office Automation	10.10.2022 to 21.10.2022	157
3	A Two-Week Add-On program on Advanced Simulation and Modelling program	10.10.2022 to 22.10.2022	32
4	A Two-Week Add-On program on ON-Grid & OFF-Grid Solar Power Generation	14.11.2022 to 26.11.2022	33
5	A Two-Week Add-On program on Web Development Using DJANGO	05.12.2022 to 17.12.2022	15
6	A Two-Week Add-On program on Fuels	15.12.2022 to 28.12.2022	110
7	A Two-Week Add-On program on Work life balance	26.12.2022 to 07.01.2023	97
8	A Two-week Add-On program on Drone Technology	06.02.2023 to 17.02.2023	48
9	A Two-Week Add-On program on V-SAT Principles of Satellite Communications	13.02.2023 to 25.02.2023	55
10	A Two-Week Add-On program on Mergers and Take over	13.03.2023 to 25.03.2023	91
11	A Two-Week Add-On program on Construction Project Management by using Primavera P6	27.03.2023 to 06.04.2023	26
12	A Two-Week Add-On program on Game Design Using Unity 3D	27.03.2023 to 06.04.2023	92
13	A Two-Week Add-On program on 4 <sup>th</sup> Industrial Revolution using Industry 4.0	03.04.2023 to 15.04.2023	74
14	A Two-Week Add-On program on Modeling of Drinking water Distribution Systems using EPANET	10.04.2023 to 21.04.2023	41
15	A Two-Week Add-On program on Statistical Distributions	08.05.2023 to 19.05.2023	102

  
IQAC

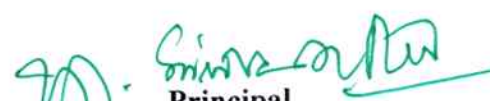
  
Principal  
PRINCIPAL  
SRI SIVANI COLLEGE OF ENGINEERING  
Chilakapalem Jn., SRIKAKULAM





# SRI SIVANI COLLEGE OF ENGINEERING

(Under the Management of Sri Sivani Educational Society, Srikakulam)  
(Approved by AICTE, New Delhi and Affiliated to JNTUGV, Vizianagaram-CC-W6,  
UGC Recognition under 2(f) & 12(B), ISO 9001:2015 Certified)  
NH-16, Chilakapalem Jn., Srikakulam Dist. Andhra Pradesh -532410

Date: 03-09-2022

## CIRCULAR

This is to inform that the Department of Electronics & Communication of Engineering is organizing A Two Week Add-On Program on “Computer vision and image processing” during 12-09-2022 to 24-09-2022 to the final year & third year ECE students to enhance their skills applicable for job opportunities. In this regard, I suggest all the students to enroll for this course on or before 7<sup>th</sup> September 2022.











Venue: VLSI Lab, Block – 2, SSCE.

Coordinator: Mrs. B.Nagaratnam ,Asst. Prof,

Department of Electronics& Communication of Engineering

  
Principal  
PRINCIPAL  
SRI SIVANI COLLEGE OF ENGINEERING  
Chilakapalem Jn., SRIKAKULAM

### Copy to

Dept.	IQAC	Civil	EEE	Mech	ECE	CSE	H&BS	MBA	TPO	Office	Library
Signature											

CC To: The Management: for information.



# SRI SIVANI COLLEGE OF ENGINEERING

(Under the Management of Sri Sivani Educational Society, Srikakulam)  
(Approved by AICTE, New Delhi and Affiliated to JNTUGV, Vizianagaram-CC-W6,  
UGC Recognition under 2(f) & 12(B), ISO 9001:2015 Certified)  
NH-16, Chilakapalem Jn., Srikakulam Dist. Andhra Pradesh -532410

## Department of Electronics and Communication Engineering

Academic Year: 2022-2023

Date: 03-9-2022

Name of the program: A Two Week Add-On program on "Computer vision and image processing"

### PROGRAM SCHEDULE

S.No	Date	Topics o be Covered
1	12-9-2022	Introduction about the image processing, image acquisition
2	13-9-2022	Image enhancement, image restoration, image segmentation, image representation, what is image analysis
3	14-9-2022	Image synthesis and image compression, types of images.
4	15-9-2022	Explained about the types of computer vision
5	16-9-2022	Image segmentation, object detection, facial reorganization
6	17-9-2022	Edge detection, uses of computer vision such as medical diagnosis, security systems
7	19-9-2022	Difference between computer vision and AI
8	20-9-2022	Characteristics of computer vision
9	21-9-2022	Components of computer vision
10	22-9-2022	Explained about the basic types of machine vision system
11	23-9-2022	1D vision systems, 2D vision systems, line scan and 3D system
12	24-9-2022	Advantages and the applications of computer vision

*B. Nagarathnam*  
Program co-ordinator

*Shreejitha*  
Head of the Department



## ABOUT THE INSTITUTION

Sri Sivani College of Engineering (SSCE) is one of the colleges functioning under Sri Sivani Educational Society, established in 2006 affiliated to JNTUGV, Vizianagaram. UGC Recognition under 2(f) & 12(B). ISO 9001:2015 Certified. SSCE is situated in a spacious 12 acres campus adjacent to NH-16 at Chilakapalem, Srikakulam, Andhra Pradesh.

SSCE offers B. Tech programs in Civil, C.S.E, E.E.E, E.C.E, Mechanical Engineering and PG programmes M.B.A, M.Tech and Diploma programmes for Civil, E.E.E and Mechanical Engineering. Fully connected through Fiber Optics and Wi-Fi Networks, Endowed with fully Qualified, well experienced and seasoned faculty members equipped with industrial experience and fully established laboratories with state-of-the-art technologies meets the growing needs of the students.

## ABOUT THE DEPARTMENT

The Department of Electronics and Communications Engineering was established in the academic year 2006-07 with an annual intake of 60. Since its commencement, the primary objective of the department has been to impart quality education, training and research at the undergraduate levels in Electronics and Communication Engineering with broad emphasis on design aspects of electronic systems.

The intake was increased to 120 from the academic year 2008-09. Five batches of students have graduated so far. The Department is offering two M.Tech courses Digital Electronics & Communication Systems and VLSI (VLSI). The first PG program DECS (Digital Electronics and Communication Systems) was started in the year 2010. The rapid developments in the field of Electronics triggered the inception of another PG programme on VLSI in the year 2011.

The Department has sufficient spacious classrooms, well-equipped laboratories with an excellent infrastructure. The department has conducted many technical symposiums under the societies of IETE, ISTE and student association named MICROS (Minds of Innovative Communicative and Resplendent Organizing Society) and also has a close interaction with the alumni where their inputs are being used continuously for the improvement of curriculum.

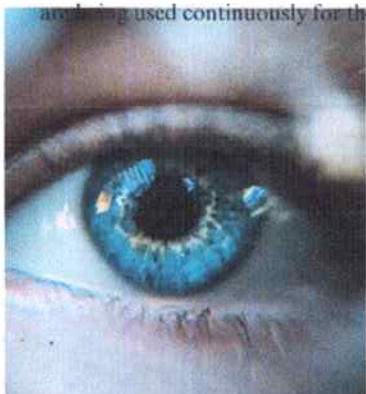

## Image Processing and Computer Vision

## PATRONS

**Sri. V.M.M. Sainadh Reddy, President,**  
**Sri. J. Suryachandra Rao, Vice President,**  
**Sri. K. Durga Srinivas, Secretary,**  
**Sri. D. Venkata Rao, Treasurer,**  
**Sri. P. Durga Prasad Raju, Joint Secretary,**  
**Dr.S. Srinivasa Rao, Correspondent**



## CHAIRMAN

**Dr. Y.Srinivasa Rao,**  
**Principal, SSCE**

## ORGANIZING COMMITTEE

### convener

**Mr.V. Suryanarayana**  
**Head of the Department**

### Program Co-ordinator

**Mrs.B.Nagaratnam**  
**Assistant professor**  
**Mobile:9337394308**  
**Email:smilypreeti@gmail.com**

**SRI SIVANI COLLEGE OF ENGINEERING**  
(Under the Management of Sri Sivani Educational Society, Srikakulam) (Approved by AICTE, New Delhi and Affiliated to JNTUGV, Vizianagaram-CC-W6) UGC Recognition under 2(f) & 12(B), ISO 9001:2015 Certified) NH-16, Chilakapalem Jn., Srikakulam Dist. Andhra Pradesh -532410

## SRI SIVANI COLLEGE OF ENGINEERING

**A Two-Week Add-On Program**  
**on "Computer vision and**  
**image processing"**

**12-09-2022 to 24-09-2022**

## ORGANIZED BY

**DEPARTMENT OF ELECTRONICS AND**  
**COMMUNICATION ENGINEERING**





## Objective of the Program

·To derive meaningful information from digital images, videos and other visual inputs

·To enable computing devices to correctly identify an object or person in a digital image

·Acquiring digital images( through image sensors),image processing, and image analysis to reach an understanding of digital images

### Resource Person

Mr. V.Jeevan Kumaro,M.Tech

Assistant professor

Dept of E.C.E

jeevan.vajja@gmail.com

9059029876

## PROGRAM CONTENT

1. Image enhancement, image restoration, image segmentation, image representation, what is image analysis.
2. Image synthesis and image compression, types of images.
3. The types of computer vision
4. Image segmentation, object detection, facial reorganization
5. Edge detection, uses of computer vision such as medical diagnosis, security systems
6. Difference between computer vision and AI
7. Characteristics of computer vision
8. Components of computer vision
9. The basic types of machine vision system
10. 1D vision systems, 2D vision systems, line scan and 3D system

## REGISTRATION FORM

### A TWO -WEEK ADD-ON PROGRAM ON "COMPUTER VISION AND IMAGE PROCESSING"

Participant's Name:

Gender: Male/Female

Educational Qualifications:

Department:

Organization:

Address :

Phone No:

Email:

Date:

Signature of the Participant:

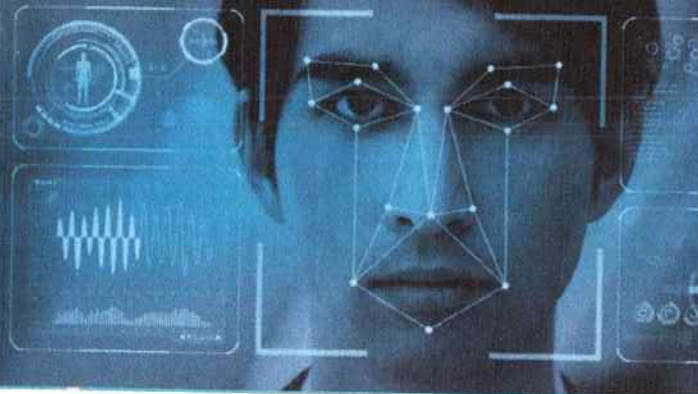





# SRI SIVANI COLLEGE OF ENGINEERING

(Under the Management of Sri Sivani Educational Society, Srikakulam)  
(Approved by AICTE, New Delhi and Affiliated to JNTUGV, Vizianagaram-CC-W6,  
UGC Recognition under 2(f) & 12(B), ISO 9001:2015 Certified)  
NH-16, Chilakapalem Jn., Srikakulam Dist. Andhra Pradesh -532410

## Department of Electronics and Communication Engineering

Academic Year: 2022-2023

Date: 12-09-2022

Name of the Program: A Two Week Add-On program on "Computer vision and image processing"

### List of Enrolled Students

S.No	Roll No	Name of The Student	Year-Sem	Signature
1	19W61A0401	A. Kartheek	IV-I	A. Kartheek
2	19W61A0402	B. Navya	IV-I	B. Navya
3	19W61A0403	G. Bhavani	IV-I	G. Bhavani
4	19W61A0404	K. Soma Sundar	IV-I	K. Soma Sundar
5	19W61A0405	K. Naveen	IV-I	K. Naveen
6	19W61A0406	P. Yamuna	IV-I	P. Yamuna
7	19W61A0407	P. Pavani	IV-I	P. Pavani
8	19W61A0408	R. Saiprasad	IV-I	R. Saiprasad
9	19W61A0409	Sateeshkumar Korikana	IV-I	K. Sateesh Kumar
10	19W61A0410	T. Sai Kumar	IV-I	T. Saikumar
11	20W65A0401	P. Rishanth	IV-I	P. Rishanth
12	20W65A0402	P. Roshini	IV-I	P. Roshini
13	20W61A0401	A. Murali	III-I	A. Murali
14	20W61A0402	A. V. Mallikarjuna Reddy	III-I	A. V. M. Reddy
15	20W61A0403	A. Vandana	III-I	A. Vandana
16	20W61A0404	B. Bhargavaram	III-I	B. Bhargavaram
17	20W61A0407	B. Kusuma	III-I	B. Kusuma

18	20W61A0408	B. Chandu	III-I	B. Chandu
19	20W61A0410	G. Sushma	III-I	G. Sushma
20	20W61A0411	G. Tarun Kumar	III-I	G. Tarun Kumar
21	20W61A0414	K. Ashok	III-I	K. Ashok
22	20W61A0416	K. Mounika	III-I	K. Mounika
23	20W61A0417	K. Sai Vineeth	III-I	K. Sai Vineeth
24	20W61A0418	K. Sri Ramya	III-I	K. Sri Ramya
25	20W61A0420	K. Sujatha	III-I	K. Sujatha
26	20W61A0421	K. Pavan Kumar	III-I	K. Pavan Kumar
27	20W61A0422	L. Sankara Rao	III-I	L. Sankara Rao
28	20W61A0423	M. Vamsikrishna	III-I	M. Vamsi Krishna
29	20W61A0424	M. Venkata Sai	III-I	M. Venkat Sai
30	20W61A0425	M. Venkata Ramana	III-I	M. Venkataramana
31	20W61A0426	M. Kamaraju	III-I	M. Kamaraju
32	20W61A0429	P. Pavan	III-I	P. Pavan
33	20W61A0430	P. Swetha	III-I	P. Swetha
34	20W61A0431	P. Anil Kumar	III-I	P. Anil Kumar
35	20W61A0432	P. Bhavani	III-I	P. Bhavani
36	20W61A0433	R. Sudheer	III-I	R. Sudheer
37	20W61A0435	Sai Swapna Surabattula	III-I	S. Sai Swapna
38	20W61A0436	S. Chandini	III-I	S. Chandini
39	20W61A0437	S. Nagaraju	III-I	S. Nagaraju
40	20W61A0439	S. Bhagyalakshmi	III-I	S. Bhagyalakshmi
41	20W61A0441	T. Divya	III-I	T. Divya
42	20W61A0444	T. Prasanna	III-I	T. Prasanna
43	20W61A0446	V. Santosh	III-I	V. Santosh
44	20W61A0447	Y. Bhanu Prakash	III-I	Y. Bhanu Prakash



45	21W65A0401	B. Mounika	III-I	B. Mounika.
46	21W65A0403	D. Pradeep	III-I	D. Pradeep
47	21W65A0404	K. Gayatri	III-I	K. Gayathri
48	21W65A0405	S. Sridhar	III-I	S. Sridhar
49	21W65A0406	S. Susmitha	III-I	S. Susmitha
50	21W65A0408	V. Sai Govind	III-I	V. Sai Govind

*B. Nagarathnam*  
Program co-ordinator

*S. Pradeep*  
Head of the Department





24	20W61A0418	K. Sri Ramya	P	P	P	P	P	P	P	P	P	P	P	P
25	20W61A0420	K. Sujatha	P	P	P	P	P	P	P	P	P	P	P	P
26	20W61A0421	K. Pavan Kumar	P	P	P	P	P	P	P	P	P	P	P	P
27	20W61A0422	L. Sankara Rao	P	P	P	P	P	P	P	P	P	P	P	A
28	20W61A0423	M. Vamsikrishna	P	P	P	P	A	P	P	P	P	P	P	P
29	20W61A0424	M. Venkata Sai	P	P	P	P	P	P	P	P	P	P	P	P
30	20W61A0425	M. Venkata Ramana	P	P	A	P	P	P	P	P	P	P	P	P
31	20W61A0426	M.Kamaraju	P	P	P	P	P	P	P	P	P	P	P	P
32	20W61A0429	P. Pavan	P	A	P	P	P	P	A	P	P	A	P	P
33	20W61A0430	P. Swetha	P	P	P	P	P	P	P	P	P	P	P	P
34	20W61A0431	P. Anil Kumar	P	P	P	P	P	P	P	P	P	P	A	P
35	20W61A0432	P. Bhavani	A	P	P	P	P	P	P	P	P	P	P	P
36	20W61A0433	R. Sudheer	P	A	P	A	P	P	P	P	P	P	P	P
37	20W61A0435	Sai Swapna S	P	P	A	P	P	P	P	P	P	P	P	P
38	20W61A0436	S. Chandini	P	P	P	P	P	P	P	P	P	P	P	P
39	20W61A0437	S. Nagaraju	P	P	P	P	P	P	P	P	P	P	P	P
40	20W61A0439	S. Bhagyalakshmi	P	P	P	P	P	P	A	P	P	P	P	P
41	20W61A0441	T. Divya	P	P	A	P	P	P	P	P	A	P	P	P
42	20W61A0444	T. Prasanna	P	P	P	P	P	P	P	P	P	P	P	P
43	20W61A0446	V. Santosh	P	P	P	P	P	P	P	P	P	P	P	P
44	20W61A0447	Y. Bhanu Prakash	P	P	P	P	P	P	P	A	P	P	P	P
45	21W65A0401	B. Mounika	P	P	P	P	P	P	P	P	P	P	P	P
46	21W65A0403	D. Pradeep	P	P	P	P	P	A	P	P	P	P	P	P
47	21W65A0404	K. Gayatri	P	P	P	P	P	P	P	P	P	P	P	A
48	21W65A0405	S. Sridhar	P	P	P	P	P	P	P	P	P	P	P	P
49	21W65A0406	S.Susmitha	A	P	P	P	P	P	P	P	P	P	P	P
50	21W65A0408	V. Sai Govind	P	P	P	A	P	P	P	P	P	P	P	P
Signature:			BNS	BNS	BNS	BNS	BNS	BNS	BNS	BNS	BNS	BNS	BNS	BNS

B. Nagarathnan  
Program co-ordinator





# SRI SIVANI COLLEGE OF ENGINEERING

(Under the Management of Sri Sivani Educational Society, Srikakulam)  
(Approved by AICTE, New Delhi and Affiliated to JNTUGV, Vizianagaram-CC-W6,  
UGC Recognition under 2(f) & 12(B), ISO 9001:2015 Certified)  
NH-16, Chilakapalem Jn., Srikakulam Dist. Andhra Pradesh -532410

## Department of Electronics and Communication Engineering

Academic Year: 2022-2023

Date: 26-09-2022

### PROGRAM REPORT

Name of the program: A one week Add-on program on “Computer vision and image processing systems”

Program duration: 12-09-2022 to 24-09-2022

Details of the resource persons: V.Jeevan Kumar, M.Tech

Asst Professor

Dept. of E.C.E

Jeevan.vajja@gmail.com

Ph.no: 9059029876

Details of the Program Coordinator: B.Nagaratnam M.Tech

Assistant Professor

Dept of E.C.E.

Smily.preeti20@gmail.com

9337394308

Objectives of the program:

- To derive meaningful information from digital images, videos and other visual inputs
- To enable computing devices to correctly identify an object or person in a digital image
- Acquiring digital images( through image sensors),image processing, and image analysis to reach an understanding of digital images

Topics covered:

- Introduction about the image processing, image acquisition
- Image enhancement, image restoration, image segmentation, image representation, what is image analysis.

- Image synthesis and image compression, types of images.
- Explained about the types of computer vision
- Image segmentation, object detection, facial reorganization
- Edge detection, uses of computer vision such as medical diagnosis, security systems
- Difference between computer vision and AI
- Characteristics of computer vision
- Components of computer vision
- Explained about the basic types of machine vision system
- 1D vision systems, 2D vision systems, line scan and 3D system
- Advantages and the applications of computer vision



**Outcome of the program:**

- Recognize and describe how mathematical and scientific concepts applied in computer vision
- Identify and interpret appropriate sources of information relating to computer vision
- Student will gain knowledge on fundamental concepts of a image processing system.

**Number of Participants: 50**

*B Nagarathnam*  
Program Co-ordinator



# SRI SIVANI COLLEGE OF ENGINEERING



(Under the Management of Sri Sivani Educational Society, Srikakulam)  
(Approved by AICTE, New Delhi and Affiliated to JNTUGV, Vizianagaram-CC-W6,  
UGC Recognition under 2(f) & 12(B), ISO 9001:2015 Certified)  
NH-16, Chilakapalem Jn., Srikakulam Dist, Andhra Pradesh -532410

## CERTIFICATE OF PARTICIPATION

This is to certify that Mr./Ms. B. Navya bearing roll no  
19061A0020 of IV year I Semester has completed A Two-Week Add-On Program on  
“COMPUTER VISION & IMAGE PROCESSING” during the period 12-09-2022 to 24-09-2022  
organized by Department of Electronics and Communication Engineering

*B. Nagarathnan*  
CO-ORDINATOR

*Shreejyoti*  
HOD

*Y. Srinivasan*  
PRINCIPAL



# SRI SIVANI COLLEGE OF ENGINEERING



(Under the Management of Sri Sivani Educational Society, Srikakulam)  
(Approved by AICTE, New Delhi and Affiliated to JNTUGV, Vizianagaram-CC-W6,  
UGC Recognition under 2(f) & 12(B), ISO 9001:2015 Certified)  
NH-16, Chilakapalem Jn., Srikakulam Dist, Andhra Pradesh -532410

## CERTIFICATE OF PARTICIPATION

This is to certify that Mr./Ms. K. Soma Sundar bearing roll no  
19W61A0404 of IV year I Semester has completed A Two-Week Add-On Program on  
"COMPUTER VISION & IMAGE PROCESSING" during the period 12-09-2022 to 24-09-2022  
organized by Department of Electronics and Communication Engineering

*B. Nagarathnam*  
CO-ORDINATOR

*Shreejane*  
HOD

*P. Srinivasulu*  
PRINCIPAL

# SRI SIVANI COLLEGE OF ENGINEERING



(Under the Management of Sri Sivani Educational Society, Srikakulam)  
(Approved by AICTE, New Delhi and Affiliated to JNTUGV, Vizianagaram-CC-W6,  
UGC Recognition under 2(f) & 12(B), ISO 9001:2015 Certified)  
NH-16, Chilakapalem Jn., Srikakulam Dist, Andhra Pradesh -532410

## CERTIFICATE OF PARTICIPATION

This is to certify that Mr./Ms. Cr. Bhavani bearing roll no  
196261A0403 of IV year I Semester has completed A Two-Week Add-On Program on  
“COMPUTER VISION & IMAGE PROCESSING” during the period 12-09-2022 to 24-09-2022  
organized by Department of Electronics and Communication Engineering

B. Nagarathnam  
CO-ORDINATOR

Shreyani  
HOD

M. Subramanian  
PRINCIPAL



# SRI SIVANI COLLEGE OF ENGINEERING



(Under the Management of Sri Sivani Educational Society, Srikakulam)  
(Approved by AICTE, New Delhi and Affiliated to JNTUGV, Vizianagaram-CC-W6,  
UGC Recognition under 2(f) & 12(B), ISO 9001:2015 Certified)  
NH-16, Chilakapalem Jn., Srikakulam Dist, Andhra Pradesh -532410

## CERTIFICATE OF PARTICIPATION

This is to certify that Mr./Ms. A. Kothare bearing roll no  
19061A0401 of IV year I Semester has completed A Two-Week Add-On Program on  
"COMPUTER VISION & IMAGE PROCESSING" during the period 12-09-2022 to 24-09-2022  
organized by Department of Electronics and Communication Engineering

*B Nagarathnam*  
CO-ORDINATOR

*Shreejaya*  
HOD

*M. Srinivasulu*  
PRINCIPAL



# SRI SIVANI COLLEGE OF ENGINEERING

(Under the Management of Sri Sivani Educational Society, Srikakulam)  
(Approved by AICTE, New Delhi and Affiliated to JNTUGV, Vizianagaram-CC-W6,  
UGC Recognition under 2(f) & 12(B), ISO 9001:2015 Certified)  
NH-16, Chilakapalem Jn., Srikakulam Dist. Andhra Pradesh -532410

Date: 26-09-2022

## CIRCULAR







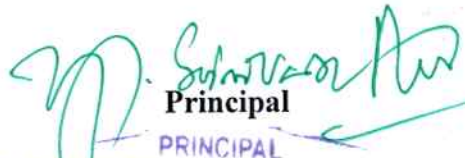

This is to inform that the Department of Computer Science and Engineering is organizing A Two-Week Add-On Program on “Web Designing and Office Automation” during 10-10-2022 to 21-10-2022 to the third year and fourth year CSE students to enhance their programming knowledge applicable for job opportunities. The goal of the Web-Designing and Office Automation Provides skills and graphic design competencies in software required for effective work practices in this sector. In this regard, I suggest all the third year and fourth CSE students to enroll this course without fail on or before 30-09-2022.

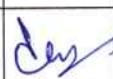
**Venue:** Block -1, CP LAB-2, SSCE

**Co-ordinator:** Mr.S.Kalyan, Asst. Prof,  
Department of Computer Science and Engineering

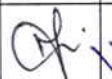
  
**Principal**  
PRINCIPAL  
SRI SIVANI COLLEGE OF ENGINEERING  
Chilakapalem Jn., SRIKAKULAM

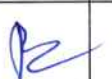
### Copy to

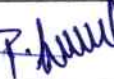
Dept.	IQAC	CIVIL	EEE	MECH	ECE	CSE	H&BS	MBA	TPO	Office	Library
Signature											

CC To: The Management: for information.





# SRI SIVANI COLLEGE OF ENGINEERING

(Under the Management of Sri Sivani Educational Society, Srikakulam)  
(Approved by AICTE, New Delhi and Affiliated to JNTUGV, Vizianagaram-CC-W6,  
UGC Recognition under 2(f) & 12(B), ISO 9001:2015 Certified)  
NH-16, Chilakapalem Jn., Srikakulam Dist. Andhra Pradesh -532410

## Department of Computer Science & Engineering

Academic Year: 2022-23

Date: 26-09-2022

Name of the program: A Two-Week Add-On Program on "Web Designing and Office Automation"

### PROGRAMME SCHEDULE

S.NO.	DATE	Topics To Be Covered
1	10/10/2022	Fundamentals Of Computers
2	11/10/2022	GUI And CUI Based Operating System
3	12/10/2022	Office Automation And Assistive Technology
4	13/10/2022	Internet And Html
5	14/10/2022	Creating And Editing Document
6	15/10/2022	Storage Information And Storage Exchange
7	17/10/2022	Basics Of Web Publishing
8	18/10/2022	<ul style="list-style-type: none"><li>• Java Script Conditionals,</li><li>• Java Script Scope</li></ul>
9	19/10/2022	Demonstrate The Use Of CSS Box Model
10	20/10/2022	Create Dynamic Web Pages Using Java Script
11	21/10/2022	Java Script For Web Developers

  
Program Co-ordinator

  
Head of the Department



### **Program Schedule:**

- Fundamentals Of Computers
- GUI And CUI Based Operating System
- Office Automation And Assistive Technology
- Internet And Html Creating And Editing Document
- Storage Information And Storage Exchange
- Basics Of Web Publishing
- Java Script Conditionals
- Java Script Scope

### **Objectives of the program:**

- Providing quality content on your website,regularly adding new information,establishing trust and marketing your site on other websites and social media.
- website design goals and objectives allows you to stay focused.
- In other words, your website goals and objective should be the backbone of your website merchandise.

### **Outcome of the program**

- The main aim of this course is to develop relevant skills in candidates related to computer applications, office management practices, and office automation technique
- effectively manage website projects using available resources



### **REGISTRATION FORM**

*A Two-Week Add-On Program on  
“Web Designing and Office  
Automation”  
(10-10-2022 to 21-10-2022)*

Participant's Name:

Gender: Male/ Female

Educational  
Qualifications:

Department:

Organization:

Address for  
Communication:

Email:

Phone No:

Date:

Signature of the Participant



## ABOUT THE INSTITUTION

Sri Sivani College of Engineering (SSCE) is one of the colleges functioning under Sri Sivani Educational Society, established in 2006 affiliated to JNTUGV, Vizianagaram. UGC Recognition under 2(f) & 12(B). ISO 9001:2015 Certified. SSCE is situated in a spacious 12 acres campus adjacent to NH-16 at Chilakapalem, Srikakulam, Andhra Pradesh. SSCE offers B. Tech programs in Civil, C.S.E, E.E.E, E.C.E, Mechanical Engineering and PG programmes M.B.A, M.Tech and Diploma programmes for Civil, E.E.E and Mechanical Engineering. Fully connected through Fiber Optics and Wi-Fi Networks, Endowed .

## ABOUT THE DEPARTMENT

The Department of Computer Science Engineering of Sri Sivani College of Engineering and Technology was established in the year 2006 and playing a vital role in designing, developing maintaining software and hardware for the entire college. It has been offering full time B. Tech (CSE), M.Tech (CSE) courses. The Department has been advancing at a rapid pace with the acquisition of advanced facilities and dedicated teaching faculty to properly motivate and mould the students for a better and prospective tomorrow. The Department is adequately equipped with several full fledged computer laboratories and research groups in order to enhance R & D and consult

## SRI SIVANI COLLEGE of ENGINEERING

(Under the Management of Sri Sivani Educational Society, Srikakulam) (Approved by AICTE, New Delhi and Affiliated to JNTUGV, Vizianagaram-CC-W6, UGC Recognition under 2(f) & 12(B), ISO 9001:2015 Certified) NH-16, Chilakapalem Jn., Srikakulam Dist. Andhra Pradesh -532410



### PATRONS

Sri. V.M.M.Sainadh Reddy

President

Sri.J.SuryachandraRao

Vice President

Sri.K. Durga Srinivas

Secretary

Sri.D. Venkata Rao

Treasurer

Sri. P. Durga Prasad Raju

Joint Secretary

Dr.S. Srinivasa Rao

Correspondent

### CHAIRMAN

Dr. Y. Srinivasa Rao

Principal,SSCE

Convener

Mr.M. Murali Krishna

H.O.D, Dept of CSE

### Co-ordinator

Mr. S. Kalyan, M.Tech

Assistant Professor

Dept of CSE



## A Two-Week Add-On Program on "Web Designing and Office Automation"

(10-10-2022 to 21-10-2022)

Organized by  
Department of Computer  
Science & Engineering

### Resource Person

Mr. M. Murali Krishna

Associate Professor

Dept. of C.S.E.

maadugula@gmail.com

9989294849





# SRI SIVANI COLLEGE OF ENGINEERING

(Under the Management of Sri Sivani Educational Society, Srikakulam)  
(Approved by AICTE, New Delhi and Affiliated to JNTUGV, Vizianagaram-CC-W6,  
UGC Recognition under 2(f) & 12(B), ISO 9001:2015 Certified)  
NH-16, Chilakapalem Jn., Srikakulam Dist. Andhra Pradesh -532410

## Department of Computer Science & Engineering

Academic Year: 2022-23

Date: 10-10-2022

Name of the program: A Two-Week Add-On Program on "Web Designing and Office Automation".

### List of Enrolled Students

S.No	Roll No	Name Of The Student	Year-Sem	Signature
1	20W61A0501	AashrithaPanigrahi	III-I	P. Aashritha
2	20W61A0502	Abhilash R Sivadas	III-I	A.R. Shivasdas
3	20W61A0504	A Naga Sanjay Sharma	III-I	A. n. sanjay sharma
4	20W61A0505	AvanapuNarayanamurthy	III-I	A. N. Narayanamurthy
5	20W61A0508	BeenaGuruprasad	III-I	B. Guruprasad
6	20W61A0509	BeharaSaikumar	III-I	B. saikumar
7	20W61A0510	BejjipurapuMounika	III-I	B. Mounika
8	20W61A0511	BiddikaJyothi	III-I	B. jyothi
9	20W61A0512	BodigiApoorva	III-I	B. APOORVA
10	20W61A0514	BorraRavindra	III-I	B. Ravindra
11	20W61A0515	Brahma Swethanjali	III-I	B. Swethanjali
12	20W61A0516	BusiJeevitha	III-I	B. Jeevitha
13	20W61A0517	DaddululGiribabu	III-I	D. giribabu
14	20W61A0518	DasariTarun	III-I	D. Tarun
15	20W61A0519	DasuSivasankaraVaraprasad	III-I	D. Sivasankara
16	20W61A0520	DungaRachana	III-I	D. Rachana
17	20W61A0521	DuppatlaBharath	III-I	D. Bharath
18	20W61A0522	GandepalliSaikumar	III-I	G. Sai Kumar
19	20W61A0523	Gangada Chandrika	III-I	G. chandrika
20	20W61A0524	Gantyada Urmila	III-I	G. Urmila
21	20W61A0525	GaruguDeevan Kumar	III-I	G. Deevan
22	20W61A0526	GavidiVamsi	III-I	G. Vamsi
23	20W61A0527	Gnaneswara Rao B	III-I	G. Swara Rao
24	20W61A0528	GorleSampath Sai	III-I	G. Sai
25	20W61A0529	Guntamukkala Deepak	III-I	G. Deepak
26	20W61A0530	HemanthkumarCh	III-I	Hemanth Kumar Ch
27	20W61A0531	InumulaDurga Prasad	III-I	Ch. Hemanthkumar
28	20W61A0532	Jami Sai	III-I	J. Sai
29	20W61A0534	KalisettiLavanya	III-I	K. Lavanya
30	20W61A0535	KanakalaVenkatesh	III-I	K. Venkatesh
31	20W61A0537	KellaMrudhulaShivani	III-I	K. Mrudhula Shivani
32	20W61A0538	KodiTulasi	III-I	K. Tulasi
33	20W61A0541	Kota Neeraja	III-I	K. Neeraja



34	20W61A0542	Kottisa Kumar	III-I	K. KUMAR
35	20W61A0543	KoyyanaMurali	III-I	K. murali
36	20W61A0544	LatchubothuAruna	III-I	L. Aruna
37	20W61A0546	Maddila Sai Priya	III-I	m. Sai priya
38	20W61A0547	Madugula Narendra	III-I	M. narendra
39	20W61A0548	MajjiDurgaBhavani	III-I	M. Durga bhavani
40	20W61A0549	Mandangi Kiran	III-I	m. kiran
41	20W61A0551	Meesala Ajay Kumar	III-I	M. Ajay Kumar
42	20W61A0552	Meesala Jyotsna	III-I	M. Jyotsna
43	20W61A0554	MuddadaSravani	III-I	M. Sravani
44	20W61A0555	Naveen Bouri	III-I	B. NAVEEN
45	20W61A0556	NerellaAravind	III-I	N. Aravind
46	20W61A0557	PagotiThanuja	III-I	P. Thanuja
47	20W61A0558	PailaSyamchandu	III-I	p. syamchandu
48	20W61A0559	Panigrahi Sai Lakshmi	III-I	P. sailakshmi
49	20W61A0560	PeetambaraSireesha	III-I	P. Sireesha
50	20W61A0561	PillaRushitha	III-I	P. Rushitha
51	20W61A0562	PotnuruNikhitha	III-I	P. Nikitha
52	20W61A0563	Potnuru Ramya	III-I	P. Ramya
53	20W61A0564	RajapantulaTarun	III-I	R. Tarun
54	20W61A0565	Rajapu Surya Prakash	III-I	R. Surya Prakash
55	20W61A0568	RokkamHarshavardan	III-I	R. Harshavardan
56	20W61A0569	SanapalaVenkata Sai	III-I	S. Venkata Sai
57	20W61A0570	Sattaru Chaitanya	III-I	S. Chaitanya
58	20W61A0572	SepenaAnusha	III-I	S. ANUSHA
59	20W61A0573	SimmalaSaikumar	III-I	S. Sai Kumar
60	20W61A0574	SurapareddyBhagyaraj	III-I	S. Bhagyaraj
61	20W61A0576	TompalaMounika	III-I	T. Mounika
62	20W61A0577	T Venkata Naveen	III-I	T. Venkata Naveen
63	20W61A0578	U Bhavana	III-I	U. Bhavana
64	20W61A0579	V Naveen Kumar	III-I	V. Naveen Kumar
65	20W61A0581	V Venkata Sri Sravya	III-I	V.V.S. Sravya
66	20W61A0583	Yandava Santhosh	III-I	Y. Santhosh
67	20W61A0586	Yenni Mani Vara Prasad	III-I	Y. mani vara prasad
68	21W65A0501	Shankar Narayana	III-I	S. Narayana
69	21W65A0502	B Janardhana	III-I	B. Janardhan
70	21W65A0504	K Santosh Kumar	III-I	K. Santosh Kumar
71	21W65A0505	M Vinay	III-I	M. Vinay
72	21W65A0506	P Revanth	III-I	P. Revanth
73	21W65A0507	R VenkataRamana	III-I	R. Venkata Ramana
74	21W65A0508	V A Prasannakumar	III-I	V. A. Prasannakumar
75	19511A0507	PereddiMeghana	IV-I	P. Meghana
76	19W61A0501	AllamsettiLikhitha	IV-I	A. Likhitha
77	19W61A0502	AlubelliAkhila	IV-I	A. Akhila
78	19W61A0503	Appikondabhavana	IV-I	A. bhavana
79	19W61A0504	BagaSuraj	IV-I	B. Suraj
80	19W61A0505	Basina Bhargavi	IV-I	B. Bhargavi
81	19W61A0506	BatnaDurga Prasad	IV-I	B. Durga Prasad
82	19W61A0507	BejjipuramIndupriya	IV-I	B. Indupriya



83	19W61A0508	BiddikaPareso	IV-I	B. Pareso.
84	19W61A0509	BiddikaSampath Kumar	IV-I	B. Sampath Kumar
85	19W61A0510	SanapalaAkanksha	IV-I	S. AKANKSHA
86	19W61A0513	Chukka Pooja	IV-I	Ch. Pooja
87	19W61A0514	DandasiPawan Kumar	IV-I	D. Pawan Kumar
88	19W61A0515	DakaraChandini	IV-I	D. Chandini
89	19W61A0517	DokiSharmila	IV-I	D. Sharmila
90	19W61A0518	DunnaSumalatha	IV-I	D. Sumalatha
91	19W61A0519	DunnaSwetha	IV-I	D. Swetha
92	19W61A0520	ErinjilaChanikya	IV-I	E. Chanikya
93	19W61A0521	Gangavarapu Uma Maheswari	IV-I	G. Uma Maheswari
94	19W61A0522	VandanaAnilkumar	IV-I	V. Anilkumar
95	19W61A0523	GarbhanaJyothsna	IV-I	G. Jyothsna
96	19W61A0524	GodabaDileep	IV-I	G. Dileep
97	19W61A0525	GopilliHymavathi	IV-I	G. HYMAVATHI
98	19W61A0526	GorleSomeswara Rao	IV-I	G. S. Rao
99	19W61A0527	Gudla.Kishore	IV-I	G. Kishore
100	19W61A0528	GundalaManoj Kumar	IV-I	G. Manoj Kumar
101	19W61A0529	GuravanaJyotshna	IV-I	G. Jyotshna
102	19W61A0530	Jada Pravalika	IV-I	J. Pravalika
103	19W61A0531	JalariKeerthi	IV-I	J. Keerthi
104	19W61A0532	JanmahanthiBharath Vamsi	IV-I	J. B. Vamsi
105	19W61A0533	KelamSanjaykumar	IV-I	K. Sanjaykumar
106	19W61A0534	Killamsetti.Dhanunjayarao	IV-I	K. Dhanunjayarao
107	19W61A0535	KillanaHiranmai	IV-I	K. Hiranmai
108	19W61A0536	KimidiSupriya	IV-I	K. Supriya
109	19W61A0537	KinjarapuSai prasuna	IV-I	K. Sai prasuna
110	19W61A0538	Bhagyasri	IV-I	BHAGYASRI
111	19W61A0539	Korada Jaya Santosh	IV-I	K. Jayasantosh
112	19W61A0540	Kottavalasa Ramesh Naidu	IV-I	K. Ramesh Naidu
113	19W61A0541	Koyyana Sai Mythree	IV-I	Koyyana Sai Mythree
114	19W61A0542	KuritiSuneelkumar	IV-I	K. Suneelkumar
115	19W61A0543	LadiAnila	IV-I	L. Anila
116	19W61A0544	LavetiBhanu	IV-I	L. Bhanu
117	19W61A0545	Lingam Mounika	IV-I	L. Mounika
118	19W61A0546	Lokonda Ganesh	IV-I	L. Ganesh
119	19W61A0547	MakkaVenkatesh	IV-I	M. Venkatesh
120	19W61A0548	MangiSrujana	IV-I	M. Srujana
121	19W61A0549	Marpu Kailash	IV-I	M. Kailash
122	19W61A0550	N. Divya	IV-I	N. Divya
123	19W61A0551	Neelapu Sujatha	IV-I	N. Sujatha
124	19W61A0552	Pala Sneha Reddy	IV-I	P. Sneha Reddy
125	19W61A0553	Pattika Sahul	IV-I	P. Sahul
126	19W61A0554	Pilli. Naveenkumar	IV-I	P. Naveen Kumar
127	19W61A0555	Polaki Ajay	IV-I	P. Ajay
128	19W61A0557	Puttamadhavilatha	IV-I	P. Madhavilatha
129	19W61A0558	PydiSireesha	IV-I	P. Sireesha
130	19W61A0559	PylaSaritha	IV-I	P. Saritha
131	19W61A0561	RattiSuguna	IV-I	R. Suguna



132	19W61A0562	RavuriLavanya	IV-I	R. Lavanya
133	19W61A0563	RayiYamini	IV-I	R. Yamini
134	19W61A0564	ReddiDeepti	IV-I	R. Deepti
135	19W61A0565	RunkuHarshita	IV-I	R. Harshita
136	19W61A0566	SakalabathulaHimaVarshini	IV-I	S. Hima varshini
137	19W61A0567	Billada Rani	IV-I	B. Rani
138	19W61A0568	Sanapala Jhansi	IV-I	S. Jhansi
139	19W61A0570	SavaraArun Kumar	IV-I	S. Arun Kumar
140	19W61A0571	S A Mallick	IV-I	S.A. Mallick
141	19W61A0572	Siripuram Sai	IV-I	S. Sai
142	19W61A0573	SugguGajendra Reddy	IV-I	G. G. Reddy
143	19W61A0574	Sunkari Lakshmi	IV-I	S. Lakshmi
144	19W61A0576	TanguduKavya	IV-I	T. Kavya
145	19W61A0577	Thota Manohar	IV-I	T. Manohar
146	19W61A0578	VaigalaLokesh	IV-I	V. Lokesh
147	19W61A0579	VajralaRohanth Sai	IV-I	V. Rohanth Sai
148	19W61A0580	Valla Purnima	IV-I	V. Purnima
149	19W61A0581	GanniKusuma	IV-I	G. Kusuma
150	19W61A0582	Vandana Yamuna	IV-I	V. Yamuna
151	19W61A0584	YabajiDileep	IV-I	Y. Dileep
152	19W61A0585	Yagati Chandrasekhar	IV-I	Y. Chandrasekhar
153	19W61A0586	YaparaSathvika	IV-I	Y. Sathvika
154	19W61A0587	YavarnaNavyasri	IV-I	Y. Navyasri
155	19W61A0588	Yavvari Sai Teja	IV-I	Y. Sai Teja
156	19W61A0589	YelamanchiliSankeerthana	IV-I	Y. Sankeerthana
157	20W65A0501	Adapaka Ramya	IV-I	A. Ramya

S. Kalyan

Program Co-ordinator

M. Gokarri

Head of the Department





30	20W61A0535	KanakalaVenkatesh	P	P	P	P	P	P	P	P	P	P	P	P	P
31	20W61A0537	KellaMrudhulaShivani	P	P	P	P	P	P	P	P	P	P	P	P	AB
32	20W61A0538	KodiTulasi	P	P	P	P	P	P	P	P	P	P	P	P	P
33	20W61A0541	Kota Neeraja	P	P	P	P	P	P	P	P	P	P	P	P	P
34	20W61A0542	Kottisa Kumar	P	P	P	P	P	P	P	P	P	P	P	P	P
35	20W61A0543	KoyyanaMurali	P	AB	P	P	P	P	P	P	P	P	P	P	P
36	20W61A0544	LatchubothuAruna	P	P	P	P	P	P	AB	P	P	P	P	P	P
37	20W61A0546	Maddila Sai Priya	P	P	P	P	P	P	P	P	P	P	P	P	P
38	20W61A0547	Madugula Narendra	P	P	P	P	P	P	P	P	P	P	P	P	P
39	20W61A0548	MajjiDurgaBhavani	P	P	P	P	P	P	P	P	P	P	P	P	P
40	20W61A0549	Mandangi Kiran	AB	P	P	P	P	P	P	P	P	P	P	P	AB
41	20W61A0551	Meesala Ajay Kumar	P	P	P	P	P	P	P	P	P	P	P	P	P
42	20W61A0552	Meesala Jyotsna	P	P	P	P	P	P	P	P	P	P	P	P	P
43	20W61A0554	MuddadaSravani	P	P	P	P	P	P	P	P	P	P	P	P	P
44	20W61A0555	Naveen Bouri	P	P	P	P	P	P	P	P	P	P	P	P	P
45	20W61A0556	NerellaAravind	P	P	P	P	P	P	P	P	P	P	P	AB	P
46	20W61A0557	PagotiThanuja	P	P	P	P	P	P	P	P	P	P	P	P	P
47	20W61A0558	PailaSyamchandu	P	AB	P	P	P	P	P	P	P	P	P	P	P
48	20W61A0559	Panigrahi Sai Lakshmi	P	P	P	P	P	P	P	P	P	P	P	P	P
49	20W61A0560	PeetambaraSireesha	P	P	P	P	P	P	P	P	P	P	P	P	P
50	20W61A0561	PillaRushitha	P	P	P	P	P	P	P	P	P	P	P	P	P
51	20W61A0562	PotnuruNikhitha	AB	P	P	P	P	P	P	P	P	P	P	P	P
52	20W61A0563	Potnuru Ramya	P	AB	P	P	P	P	P	P	P	P	P	P	P
53	20W61A0564	RajapantulaTarun	P	P	P	P	P	P	P	P	P	P	P	P	P
54	20W61A0565	Rajapu Surya Prakash	P	P	P	P	P	P	P	P	P	P	P	P	P
55	20W61A0568	RokkamHarshavardan	P	P	P	AB	P	P	P	P	P	P	P	P	P
56	20W61A0569	SanapalaVenkata Sai	P	P	P	P	P	P	P	P	P	P	P	P	P
57	20W61A0570	Sattaru Chaitanya	P	P	P	P	P	P	P	P	P	P	P	P	P
58	20W61A0572	SepenaAnusha	P	P	P	P	P	P	P	P	P	P	P	P	P
59	20W61A0573	SimmalaSaikumar	P	P	P	P	P	P	P	P	P	P	P	P	P
60	20W61A0574	SurapareddyBhagyaraj	P	P	P	P	P	P	P	P	P	P	P	P	P
61	20W61A0576	TompalaMounika	P	P	P	P	P	P	P	AB	P	P	P	P	P
62	20W61A0577	T Venkata Naveen	P	P	P	P	P	P	P	P	P	P	P	P	P
63	20W61A0578	U Bhavana	P	P	P	P	P	P	P	P	P	P	P	P	P
64	20W61A0579	V Naveen Kumar	P	P	P	P	P	P	P	P	AB	P	P	P	P
65	20W61A0581	V Venkata Sri Sravya	P	P	P	P	P	P	P	P	P	P	P	P	P
66	20W61A0583	Yandava Santhosh	P	P	P	P	P	P	P	P	P	P	P	P	P
67	20W61A0586	Yenni Mani Vara Prasad	P	P	P	P	P	P	P	P	P	P	P	P	P
68	21W65A0501	Shankar Narayana	P	P	P	P	P	P	P	P	P	AB	P	P	P
69	21W65A0502	B Janardhana	P	P	P	P	P	P	P	P	P	P	P	P	P
70	21W65A0504	K Santosh Kumar	P	P	P	P	P	P	P	P	P	P	P	P	P
71	21W65A0505	M Vinay	P	P	P	P	P	AB	P	P	P	P	P	P	P
72	21W65A0506	P Revanth	P	P	P	P	P	P	P	P	P	P	P	P	P
73	21W65A0507	R VenkataRamana	P	P	P	P	P	P	P	P	P	P	P	P	P
74	21W65A0508	V A Prasannakumar	P	P	P	P	P	P	P	P	P	P	P	P	P
75	19511A0507	PereddiMeghana	P	P	P	P	P	P	AB	P	P	P	P	P	P



76	19W61A0501	AllamsettiLikhitha	P	P	P	P	P	P	P	P	P	P	P	P
77	19W61A0502	AlubelliAkhila	P	P	P	P	P	P	P	P	P	P	P	P
78	19W61A0503	Appikondabhavana	AB	P	P	P	P	P	P	P	P	P	P	P
79	19W61A0504	BagaSuraj	P	P	P	P	P	P	P	P	P	P	P	P
80	19W61A0505	Basina Bhargavi	P	P	P	P	P	P	P	P	P	P	P	P
81	19W61A0506	BatnaDurga Prasad	P	P	P	P	P	AB	P	P	P	P	P	P
82	19W61A0507	BejjipuramIndupriya	P	P	P	P	P	P	P	P	P	P	P	P
83	19W61A0508	BiddikaPareso	P	P	P	P	P	P	P	P	P	P	P	P
84	19W61A0509	BiddikaSampath Kumar	P	P	P	P	P	P	P	P	P	P	P	P
85	19W61A0510	SanapalaAkanksha	P	P	P	P	P	P	P	P	P	P	P	P
86	19W61A0513	Chukka Pooja	P	P	P	P	P	P	P	P	P	P	P	P
87	19W61A0514	DandasiPawan Kumar	P	P	P	P	P	P	P	P	P	P	P	P
88	19W61A0515	DakaraChandini	P	P	AB	P	P	P	P	P	P	P	P	P
89	19W61A0517	DokiSharmila	AB	P	P	P	P	P	P	P	P	P	P	P
90	19W61A0518	DunnaSumalatha	P	P	P	P	P	P	P	P	P	P	P	P
91	19W61A0519	DunnaSwetha	P	P	P	P	P	P	P	P	P	P	P	P
92	19W61A0520	ErinjilaChanikya	P	P	P	P	P	P	P	P	P	P	P	P
93	19W61A0521	Gangavarapu Uma	P	P	P	P	P	P	P	P	P	P	P	P
94	19W61A0522	VandanaAnilkumar	P	P	P	P	P	P	P	P	P	P	P	P
95	19W61A0523	GarbhanaJyothsna	P	P	P	P	P	P	P	P	P	P	P	P
96	19W61A0524	GodabaDileep	P	P	P	P	P	P	P	P	P	P	P	P
97	19W61A0525	GopilliHymavathi	P	P	P	P	P	P	P	P	P	P	P	P
98	19W61A0526	GorleSomeswara Rao	P	P	P	P	P	P	P	P	P	P	P	P
99	19W61A0527	Gudla.Kishore	P	P	P	P	P	P	P	P	P	P	P	P
100	19W61A0528	GundalaManoj Kumar	P	P	P	AB	P	P	P	P	P	P	P	P
101	19W61A0529	GuravanaJyotshna	P	P	P	P	AB	P	P	P	P	P	P	AB
102	19W61A0530	Jada Pravalika	AB	P	P	P	P	P	P	P	P	P	P	P
103	19W61A0531	JalariKeerthi	P	P	P	P	P	P	P	P	P	P	P	P
104	19W61A0532	JanmahanthiBharath Vamsi	P	P	P	P	P	P	P	P	P	P	P	P
105	19W61A0533	KelamSanjaykumar	P	P	P	P	P	P	P	P	P	P	P	P
106	19W61A0534	Killamsetti.Dhanunjayarao	P	P	P	P	P	P	P	P	P	P	P	P
107	19W61A0535	KillanaHiranmai	P	P	P	P	P	P	AB	P	P	P	P	P
108	19W61A0536	KimidiSupriya	P	P	P	P	P	P	P	P	P	P	P	P
109	19W61A0537	KinjarapuSaiprasuna	P	P	P	P	P	P	P	P	P	P	P	P
110	19W61A0538	Bhagyasri	P	P	P	P	P	P	P	P	P	P	P	P
111	19W61A0539	Korada Jaya Santosh	P	P	P	P	P	P	P	P	P	P	P	P
112	19W61A0540	Kottavalasa Ramesh Naidu	P	P	P	P	P	P	P	P	P	P	P	P
113	19W61A0541	Koyyana Sai Mythree	P	P	P	P	P	P	P	P	P	P	P	P
114	19W61A0542	KuritiSuneelkumar	P	P	P	AB	P	P	P	P	P	P	P	P
115	19W61A0543	LadiAnila	P	P	P	P	P	P	P	P	P	P	P	P
116	19W61A0544	LavetiBhanu	P	P	P	P	P	P	P	P	P	P	P	P
117	19W61A0545	Lingam Mounika	P	P	P	P	P	P	P	P	P	P	P	P
118	19W61A0546	Lokonda Ganesh	P	P	P	P	P	P	AB	P	P	P	P	P
119	19W61A0547	MakkaVenkatesh	P	P	P	P	P	P	P	P	P	P	P	P
120	19W61A0548	MangiSrujana	P	P	P	P	P	P	P	P	P	P	P	P
121	19W61A0549	Marpu Kailash	AB	P	P	P	AB	P	P	P	P	P	P	P



122	19W61A0550	N. Divya	P	P	P	P	P	P	P	P	P	P	P	P
123	19W61A0551	Neelapu Sujatha	P	P	P	P	AB	P	P	P	P	P	P	P
124	19W61A0552	Pala Sneha Reddy	P	P	P	P	P	P	P	P	P	P	P	P
125	19W61A0553	Pattika Sahul	P	P	P	P	P	P	P	P	P	P	P	P
126	19W61A0554	Pilli. Naveenkumar	P	P	P	P	P	P	P	P	P	P	P	P
127	19W61A0555	Polaki Ajay	AB	P	P	P	P	P	AB	P	P	P	P	P
128	19W61A0557	Puttamadhavilatha	P	P	P	P	P	P	P	P	P	P	P	P
129	19W61A0558	PydiSireesha	P	P	P	P	P	P	P	P	P	P	P	P
130	19W61A0559	PylaSaritha	P	P	P	P	P	P	P	P	P	P	P	P
131	19W61A0561	RattiSuguna	P	P	P	P	P	P	P	P	P	P	P	P
132	19W61A0562	RavuriLavanya	P	P	P	P	P	P	P	P	P	P	P	P
133	19W61A0563	RayiYamini	P	P	AB	P	P	P	P	P	P	P	P	P
134	19W61A0564	ReddiDeepti	P	P	P	P	P	P	P	P	P	P	P	P
135	19W61A0565	RunkuHarshita	AB	P	P	P	P	AB	P	P	P	P	P	P
136	19W61A0566	SakalabathulaHimaVarshini	P	P	P	P	P	P	P	P	P	P	P	P
137	19W61A0567	Billada Rani	P	P	P	AB	P	P	P	P	P	P	P	P
138	19W61A0568	Sanapala Jhansi	P	P	P	P	P	P	P	P	P	P	P	AB
139	19W61A0570	SavaraArun Kumar	P	P	P	P	P	P	P	P	P	P	P	P
140	19W61A0571	S A Mallick	P	P	P	P	P	P	P	P	P	P	P	P
141	19W61A0572	Siripuram Sai	P	AB	P	P	P	P	P	P	P	P	P	P
142	19W61A0573	SugguGajendra Reddy	P	P	P	P	P	P	P	P	P	P	P	P
143	19W61A0574	Sunkari Lakshmi	P	P	P	P	P	P	P	P	P	P	P	P
144	19W61A0576	TanguduKavya	P	P	P	P	P	P	P	P	P	P	P	P
145	19W61A0577	Thota Manohar	P	P	P	P	P	P	P	P	AB	P	P	P
146	19W61A0578	VaigalaLokesh	P	P	P	P	P	P	P	P	P	P	P	P
147	19W61A0579	VajralaRohanthasai	P	P	P	P	P	P	P	P	P	P	P	P
148	19W61A0580	Valla Purnima	P	P	P	P	P	P	P	P	P	P	P	P
149	19W61A0581	GanniKusuma	P	P	P	P	P	P	P	P	P	P	P	P
150	19W61A0582	Vandana Yamuna	P	P	P	P	P	P	P	P	P	P	P	P
151	19W61A0584	YabajiDileep	P	P	P	P	P	P	P	P	P	P	P	P
152	19W61A0585	Yagati Chandrasekhar	P	P	P	P	P	P	P	P	P	P	P	P
153	19W61A0586	YaparaSathvika	P	P	P	P	P	P	P	P	P	P	P	AB
154	19W61A0587	YavarnaNavyasri	P	P	P	P	P	P	P	P	P	P	P	P
155	19W61A0588	Yavvari Sai Teja	P	P	P	P	P	P	P	P	P	P	P	P
156	19W61A0589	YelamanchiliSankeerthana	P	P	P	P	P	P	P	P	P	P	P	P
157	20W65A0501	Adapaka Ramya	P	P	P	P	P	AB	P	P	P	P	P	P
Signature			<i>[Signature]</i>	<i>[Signature]</i>	<i>[Signature]</i>	<i>[Signature]</i>	<i>[Signature]</i>	<i>[Signature]</i>	<i>[Signature]</i>	<i>[Signature]</i>	<i>[Signature]</i>	<i>[Signature]</i>	<i>[Signature]</i>	<i>[Signature]</i>

*S. Kalpana*  
Program Co-ordinator



# SRI SIVANI COLLEGE OF ENGINEERING

(Under the Management of Sri Sivani Educational Society, Srikakulam)  
(Approved by AICTE, New Delhi and Affiliated to JNTUGV, Vizianagaram-CC-W6,  
UGC Recognition under 2(f) & 12(B), ISO 9001:2015 Certified)  
NH-16, Chilakapalem Jn., Srikakulam Dist. Andhra Pradesh -532410

## Department of Computer Science & Engineering

Academic year: 2022-2023

Date: 22-10-2022

### PROGRAM REPORT

**Name of the Program:** A Two-Week Add-On Program on “Web Designing and Office Automation”

**Program Duration:** 10-10-2022 to 21-10-2022

**Details of the Resource Person:** Mr. M.Murali Krishna, M.Tech  
Associate Professor  
Dept. of C.S.E.  
[madugula@gmail.com](mailto:madugula@gmail.com)  
9989294849

**Details of the Program coordinator:** Mr. S.Kalyan, M.Tech,  
Assistant Professor  
Dept. of C.S.E.  
[kalyans25@gmail.com](mailto:kalyans25@gmail.com)  
9030756851

#### Objectives of the program:

- Providing quality content on your website, regularly adding new information, establishing trust, and marketing your site on other websites and social media.
- website design goals and objectives allows you to stay focused. In other words, your website goals and objective should be the backbone of your website merchandise.

#### Topics covered:

- Fundamentals Of Computers
- GUI And CUI Based Operating System
- Office Automation And Assistive Technology
- Internet And Html
- Creating And Editing Document
- Storage Information And Storage Exchange



- Basics of Web Publishing
- Java Script Conditionals
- Java Script Scope
- Demonstrate The Use of CSS Box Model
- Create Dynamic Web Pages Using Java Script



**Outcome of the program:**

- The main aim of this course is to develop relevant skills in candidates related to computer application, office management practices, and office automation technique.
- Create and maintain quality web pages, learn about web design standards and why they're important, and learn to create and manipulate images.
- Demonstrate communication skills, service management skills, and presentation skills..
- Effectively manage website projects using available resources.

**Number of Participants:** 157

*S. Kalyan*  
**Program Co-ordinator**



# SRI SIVANI COLLEGE OF ENGINEERING

(Under the Management of Sri Sivani Educational Society, Srikakulam)

(Approved by AICTE, New Delhi and Affiliated to JNTUGV, Vizianagaram-CC-W6,

UGC Recognition under 2(f) & 12(B), ISO 9001:2015 Certified)

NH-16, Chilakapalem Jn., Srikakulam Dist. Andhra Pradesh -532410

## CERTIFICATE OF PARTICIPATION

This is to certify that Mr./Ms. P. Revanth bearing  
Roll No 211065A0506 of III Year I Semester has completed A Two-Week  
Add-On Program on "Web Designing and Office Automation" during the period 10-10-2022  
to 21-10-2022 organized by Department of Computer Science Engineering.

*S. Kalyan*  
Co-ordinator

*H. Kalyan*  
HOD

*Srinivasa*  
Principal





# SRI SIVANI COLLEGE OF ENGINEERING

(Under the Management of Sri Sivani Educational Society, Srikakulam)  
(Approved by AICTE, New Delhi and Affiliated to JNTUGV, Vizianagaram-CC-W6,  
UGC Recognition under 2(f) & 12(B), ISO 9001:2015 Certified)  
NH-16, Chilakapalem Jn., Srikakulam Dist. Andhra Pradesh -532410

## CERTIFICATE OF PARTICIPATION

This is to certify that Mr./Ms. Gr. Kusuma bearing  
Roll No 196061A0581 of IV Year I Semester has completed A Two-Week  
Add-On Program on "Web Designing and Office Automation" during the period 10-10-2022  
to 21-10-2022 organized by Department of Computer Science Engineering.

*S. Kalyan*  
Co-ordinator

*H. G. K. K. K.*  
HOD

*M. G. K. K. K.*  
Principal



# SRI SIVANI COLLEGE OF ENGINEERING

(Under the Management of Sri Sivani Educational Society, Srikakulam)  
(Approved by AICTE, New Delhi and Affiliated to JNTUGV, Vizianagaram-CC-W6,  
UGC Recognition under 2(f) & 12(B), ISO 9001:2015 Certified)  
NH-16, Chilakapalem Jn., Srikakulam Dist. Andhra Pradesh -532410

## CERTIFICATE OF PARTICIPATION

This is to certify that Mr./Ms. U. Bhavana bearing  
Roll No 20C61A0578 of III Year I Semester has completed A Two-Week  
Add-On Program on "Web Designing and Office Automation" during the period 10-10-2022  
to 21-10-2022 organized by Department of Computer Science Engineering.

*S. Kalyan*  
Co-ordinator

*M. K. Keri*  
HOD

*M. Srinivasulu*  
Principal





# SRI SIVANI COLLEGE OF ENGINEERING

(Under the Management of Sri Sivani Educational Society, Srikakulam)  
(Approved by AICTE, New Delhi and Affiliated to JNTUGV, Vizianagaram-CC-W6,  
UGC Recognition under 2(f) & 12(B), ISO 9001:2015 Certified)  
NH-16, Chilakapalem Jn., Srikakulam Dist. Andhra Pradesh -532410

## CERTIFICATE OF PARTICIPATION

This is to certify that Mr./Ms. N. Divya bearing  
Roll No 19C061A0550 of IV Year I Semester has completed A Two-Week  
Add-On Program on "Web Designing and Office Automation" during the period 10-10-2022  
to 21-10-2022 organized by Department of Computer Science Engineering.

S. Kalyan  
Co-ordinator

H. G. Veni  
HOD

Srinivasan  
Principal



# SRI SIVANI COLLEGE OF ENGINEERING

(Under the Management of Sri Sivani Educational Society, Srikakulam)  
(Approved by AICTE, New Delhi and Affiliated to JNTUGV, Vizianagaram-CC-W6,  
UGC Recognition under 2(f) & 12(B), ISO 9001:2015 Certified)  
NH-16, Chilakapalem Jn., Srikakulam Dist. Andhra Pradesh -532410

Date: 29-09-2022

## CIRCULAR

Here by informed to that the Department of Electrical and Electronics Engineering is planning to organize **A Two-week Add-On Program on “Advanced Simulation and Modeling Program”** from **10-10-2022** to **22-10-2022** for 3<sup>rd</sup> & 4<sup>th</sup> year EEE students. This program is designed to enhance their skills and knowledge in the field of simulation and modeling. We are offering a two-week Advanced Simulation and Modeling Program, designed to provide participants with a comprehensive understanding of advanced techniques and applications in this dynamic field. In this regard, I suggest 3<sup>rd</sup> & 4<sup>th</sup> year EEE students should enroll this program on or before **06-10-2022**.











**Venue:** Seminar Hall, Block – 1, SSCE.

**Coordinator:** Ms. M. Sai Sudha, Asst. Prof,

Department of Electrical & Electronics Engineering

  
Principal  
PRINCIPAL  
SRI SIVANI COLLEGE OF ENGINEERING  
Chilakapalem Jn., SRIKAKULAM

### Copy to

Dept.	IQAC	Civil	EEE	Mech	ECE	CSE	H&BS	MBA	TPO	Office	Library
Signature											

CC To: The Management: for information.





# SRI SIVANI COLLEGE OF ENGINEERING

(Under the Management of Sri Sivani Educational Society, Srikakulam)  
(Approved by AICTE, New Delhi and Affiliated to JNTUGV, Vizianagaram-CC-W6,  
UGC Recognition under 2(f) & 12(B), ISO 9001:2015 Certified)  
NH-16, Chilakapalem Jn., Srikakulam Dist. Andhra Pradesh -532410

## Department of Electrical & Electronics Engineering

Academic Year: 2022-23

Date: 29-09-2022

Name of the program: A Two Week Add-On Program on “Advanced Simulation and Modeling Program”

### PROGRAM SCHEDULE

S.No	Date	Topics To Be Covered
1	10-10-2022	Introduction to Simulation and Modeling
2	11-10-2022	Introduction to Simulation and Modeling
3	12-10-2022	Probability and Statistics in Simulation
4	13-10-2022	Probability and Statistics in Simulation
5	14-10-2022	Monte Carlo Simulation
6	15-10-2022	Monte Carlo Simulation
7	17-10-2022	Discrete Event Simulation
8	18-10-2022	Discrete Event Simulation
9	19-10-2022	Agent-Based Modeling
10	20-10-2022	Agent-Based Modeling
11	21-10-2022	Advanced topics and Applications
12	22-10-2022	Advanced topics and Applications

  
Program Co-ordinator

  
Head of the Department



## About Institute

Sri Sivani College of Engineering (SSCE) is one of the colleges functioning under Sri Sivani Educational Society. SSCE is a pioneer in the field of engineering education in Srikakulam district (A.P). It was established in the year 2006 under the affiliation of JNT UGV, Vizianagaram and approved by AICTE, New Delhi. The college is UGC Recognition under 2(f) & 12(B) , ISO 9001:2015 Certified) SSCE is situated in a spacious 11 acres campus adjacent to NH-16 at chilkapalem village. The college is easily accessible to all the districts nearby Srikakulam. SSCE offers B.Tech programmes in E.E.E, E.C.E, C.S.E, Mechanical and Civil Engineering, besides PG programmes M.C.A, M.B.A, M.Tech and Diploma programmes like E.E.E, Mechanical, and Civil Engineering as second shift. SSCE is completely Wi-Fi enabled and equipped with well established laboratories. The college has focused towards student centric learning atmosphere. The faculty is well qualified, experienced equipped with state of art technologies and dedicated to produce marketable products.

## About Department

The department is well focused and student centric with clear vision. The department of Electrical and Electronics Engineering is one of the oldest and major departments of the Institute. Since its inception in 2006, the department has been actively engaged in teaching and research in diverse fields of Electrical and Electronics Engineering. The department offers B.Tech in EEE with an intake of 30 students and M.Tech in Power Electronics with an intake of 12 students. The department is strong with a few faculty members holding Ph.D degrees and expertise in various fields. The department of EEE has adequate and well-qualified faculties spanning all major areas of Electrical Engineering like Power Systems, Power Electronics and Control Systems. Apart from regular academics, department organizes department association activities to encourage and motivate the students to achieve their goals. Department also encourages the students to participate in technical events organized by other universities and colleges.

### CHIEF PATRON

Sri. V.M.M. Sainadh Reddy, President,

### PATRONS

Sri. J. Suryachandra Rao, Vice President,

Sri. K. Durga Srinivas, Secretary,

Sri. D. Venkata Rao, Treasurer,

Sri. P. Durga Prasad Raju, Joint Secretary,

Dr. S. Srinivasa Rao, Correspondent,

### PRINCIPAL

Dr. Y. Srinivas Rao,

Principal, SSCE

### Head of the Department

Mr. N. Naga Srinivas

### Program Co-ordinator

Ms. M. Sai Sudha,

Assistant professor

Mobile: 8500447055

Email: [majjisaisudha@gmail.com](mailto:majjisaisudha@gmail.com)

### RESOURCE PERSONS

#### 1. Dr. S. Ramana Kumar Joga,

Assistant Professor

Dadi Institute of engineering and

Technology, Visakhapatnam

[srkjoga@diet.edu.in](mailto:srkjoga@diet.edu.in)

9490265958

#### 2. Mr. I. Sai Rajesh Kumar, M.Tech

Assistant Professor

Sri Sivani College of Engineering, Srikakulam

[sairajeshkumar03@gmail.com](mailto:sairajeshkumar03@gmail.com)

8897339445

SRI SIVANI COLLEGE OF ENGINEERING

(Approved by AICTE, New Delhi and

Affiliated to JNTUGV, Vizianagaram-CC-W6,

UGC Recognition under 2(f) & 12(B), ISO

9001:2015 Certified) NH-16, Chilakapalem Jn.,

Srikakulam Dist. 532410



## SRI SIVANI COLLEGE OF ENGINEERING

### A TWO - WEEK ADD-ON PROGRAM ON "ADVANCED SIMULATION AND MODELING PROGRAM"

**(10-10-2022 to 22-10-2022)**



**ORGANIZED BY  
DEPARTMENT OF ELECTRICAL  
& ELECTRONICS ENGINEERING**



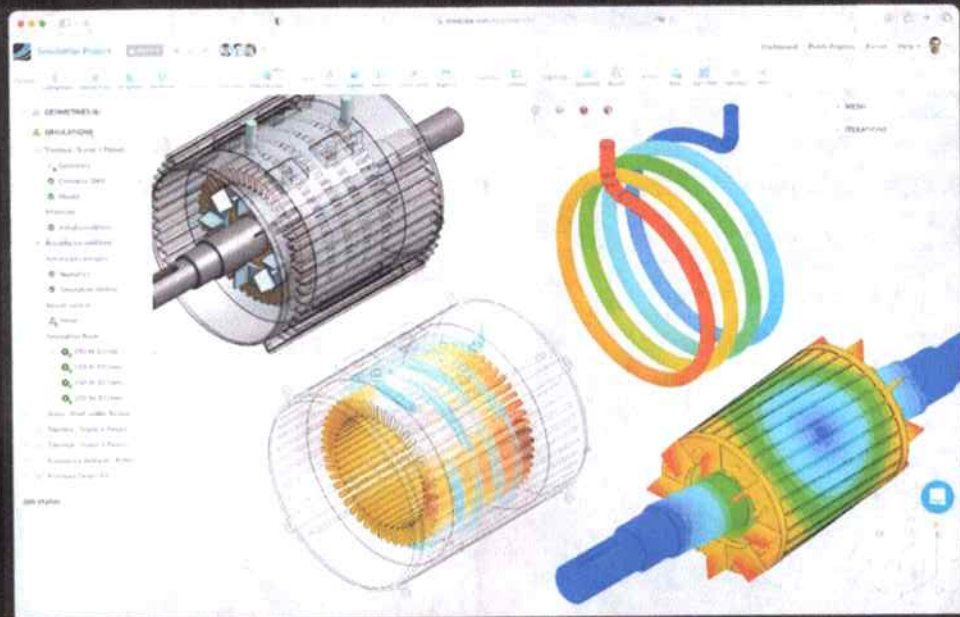

## Objectives

- To provide students with a comprehensive understanding of advanced simulation and modeling techniques and their applications across various domains.
- To equip students with the practical skills necessary to develop and optimize complex simulation models.
- To enhance students' ability to use simulation and modeling as decision-making tools for solving real-world problems.
- To explore the versatility of simulation and modeling in fields such as finance, healthcare, logistics, and more.
- To facilitate networking and collaboration among participants and experts in the field.

## Program Schedule

1. Introduction to Simulation and Modeling
2. Probability and Statistics in Simulation
3. Monte Carlo Simulation
4. Discrete Event Simulation
5. Agent-Based Modeling
6. Advanced Topics and Applications

## REGISTRATION FORM

### A TWO-WEEK ADD-ON PROGRAM ON "ADVANCED SIMULATION AND MODELING Program"

**10-10-2022 to 22-10-2022**

Participant's Name :

Gender: Male/Female :

Educational Qualification :

Department :

Organization:

Address :

Mobile Number :

Email ID :

Date:

Signature of the Participant





# SRI SIVANI COLLEGE OF ENGINEERING

(Under the Management of Sri Sivani Educational Society, Srikakulam)  
(Approved by AICTE, New Delhi and Affiliated to JNTUGV, Vizianagaram-CC-W6,  
UGC Recognition under 2(f) & 12(B), ISO 9001:2015 Certified)  
NH-16, Chilakapalem Jn., Srikakulam Dist. Andhra Pradesh -532410

## Department of Electrical & Electronics Engineering

Academic Year: 2022-23

Date: 06-10-2022

Name of the program: A Two-Week Add-On Program on "Advanced Simulation and Modeling Program".

### List of Enrolled Students

S.No	Roll Number	Name of the Student	Year-Sem	Signature
1	20W61A0203	Mandadi Charan Teja	III-I	M. Charanteja
2	20W61A0204	Mekala Vamsi	III-I	M. Vamsi
3	20W61A0206	Potnuru Lavanya	III-I	P. Lavanya
4	21W65A0201	Allu Mahesh	III-I	A. Mahesh
5	21W65A0202	Ardapakula Bhaskar	III-I	A. Bhaskar
6	21W65A0203	Badithamani Ganeswararao	III-I	B. Ganeswararao
7	21W65A0204	Mantri Devi Vara Prasad	III-I	M. Devi Varaprasad
8	21W65A0205	Battula Pavan	III-I	B. Pavan
9	21W65A0206	Konada Jagannataka Suthradhari	III-I	K. Jagannath Suthradhari
10	21W65A0207	Birlangi Manmadha Rao	III-I	B. Manmadha Rao
11	21W65A0208	Gollapalli Bharath Kumar	III-I	G. Bharath Kumar
12	21W65A0210	Busa Uday Kumar	III-I	B. Uday Kumar
13	21W65A0211	Chowdari Eswararao	III-I	Ch. Eswararao
14	21W65A0212	Damu Chakradhar	III-I	D. Chakradhar
15	21W65A0213	Gondu Narendra	III-I	G. Narendra
16	21W65A0214	Guntamukkala Ravi	III-I	G. Ravi
17	21W65A0215	Kandula Nethaji	III-I	K. Nethaji
18	21W65A0217	Ladi Sai Krishna	III-I	L. Sai Krishna
19	21W65A0218	Lanka Eswar Durga Prasad Naidu	III-I	L. E. D. Prasad Naidu
20	21W65A0219	Naidana Dhilleswara Rao	III-I	N. Dhilleswara Rao
21	21W65A0221	Palina Madhu Krishna	III-I	P. Madhu Krishna
22	21W65A0222	Panga Jagadeesh	III-I	P. Jagadeesh
23	21W65A0223	Pinninti Sasikanth	III-I	P. Sasikanth
24	21W65A0224	Raavi Ravi Teja	III-I	R. Ravi Teja
25	21W65A0225	Suvvari Ramesh	III-I	S. Ramesh
26	21W65A0226	Tarlada Sai Sumanth	III-I	T. Sai Sumanth
27	19W61A0201	Dunga Prema Kumar	IV-I	D. Prema Kumar



28	20W65A0201	Anupoju Dharma Rao	IV-I	A. Dharma Rao
29	20W65A0204	Gangada Dhilleswararao	IV-I	G. Dhilleswararao
30	20W65A0205	Kuna Santhoshikumari	IV-I	K. Santhoshikumari
31	20W65A0206	P. Satya Narayana	IV-I	P. Satya Narayana
32	20W65A0208	Yarabati Gajapathi	IV-I	Y. Gajapathi

  
Program Co-ordinator

  
Head of the Department





19	21W65A0218	Lanka Eswar Durga Prasad Naidu	P	P	P	P	P	P	P	P	P	P	AB	P
20	21W65A0219	Naidana Dhilleswara Rao	P	P	P	P	P	P	P	P	P	P	P	P
21	21W65A0221	Palina Madhu Krishna	P	P	P	P	P	P	P	P	P	P	P	P
22	21W65A0222	Panga Jagadeesh	P	P	P	P	P	P	P	P	P	P	P	P
23	21W65A0223	Pinninti Sasikanth	P	P	P	P	P	P	AB	P	P	P	P	P
24	21W65A0224	Raavi Ravi Teja	P	P	P	P	P	P	P	P	P	P	P	P
25	21W65A0225	Suvvari Ramesh	P	P	P	P	P	P	P	P	P	P	P	P
26	21W65A0226	Tarlada Sai Sumanth	P	P	P	P	P	P	P	P	P	P	P	P
27	19W61A0201	Dunga Prema Kumar	P	P	P	P	P	P	P	P	P	P	P	P
28	20W65A0201	Anupoju Dharma Rao	P	P	P	P	P	P	P	P	P	P	P	P
29	20W65A0204	Gangada Dhilleswararao	P	P	P	P	AB	P	P	P	P	P	P	P
30	20W65A0205	Kuna Santhoshikumari	P	P	P	P	P	P	P	P	P	P	P	P
31	20W65A0206	P. Satya Narayana	P	P	P	P	P	P	P	P	P	P	P	P
32	20W65A0208	Yarabati Gajapathi	P	P	P	P	P	P	P	P	P	AB	P	P
Signature :														

M. S. S.  
Program Co-ordinator



# SRI SIVANI COLLEGE OF ENGINEERING

(Under the Management of Sri Sivani Educational Society, Srikakulam)  
(Approved by AICTE, New Delhi and Affiliated to JNTUGV, Vizianagaram-CC-W6,  
UGC Recognition under 2(f) & 12(B), ISO 9001:2015 Certified)  
NH-16, Chilakapalem Jn., Srikakulam Dist. Andhra Pradesh -532410

## Department of Electrical & Electronics Engineering

Academic year: 2022-23

Date: 27-09-2022

### PROGRAM REPORT

- Name of the program** : A Two-Week Add-On Program on “Advanced Simulation and Modeling Program”
- Program Duration** : 10-10-2022 to 22-10-2022
- Details of Resource Persons** : 1. Dr. S. Ramana Kumar Joga  
Assistant Professor  
Dadi Institute of engineering and Technology  
[srkjoga@diet.edu.in](mailto:srkjoga@diet.edu.in)  
+91 94902 65958
2. Mr. I. Sai Rajesh Kumar, M.Tech  
Assistant Professor,  
Dept. of EEE,  
Sri Sivani College of Engineering  
[sairajeshkumar03@gmail.com](mailto:sairajeshkumar03@gmail.com)  
8897339445
- Details of Program coordinator** : Ms. M. Sai Sudha, M.Tech,  
Assistant Professor,  
Dept. of EEE,  
Sri Sivani College of Engineering  
[majjisaisudha@gmail.com](mailto:majjisaisudha@gmail.com)  
8500447055

### Objectives of the program:

- To provide students with a comprehensive understanding of advanced simulation and modeling techniques and their applications across various domains.



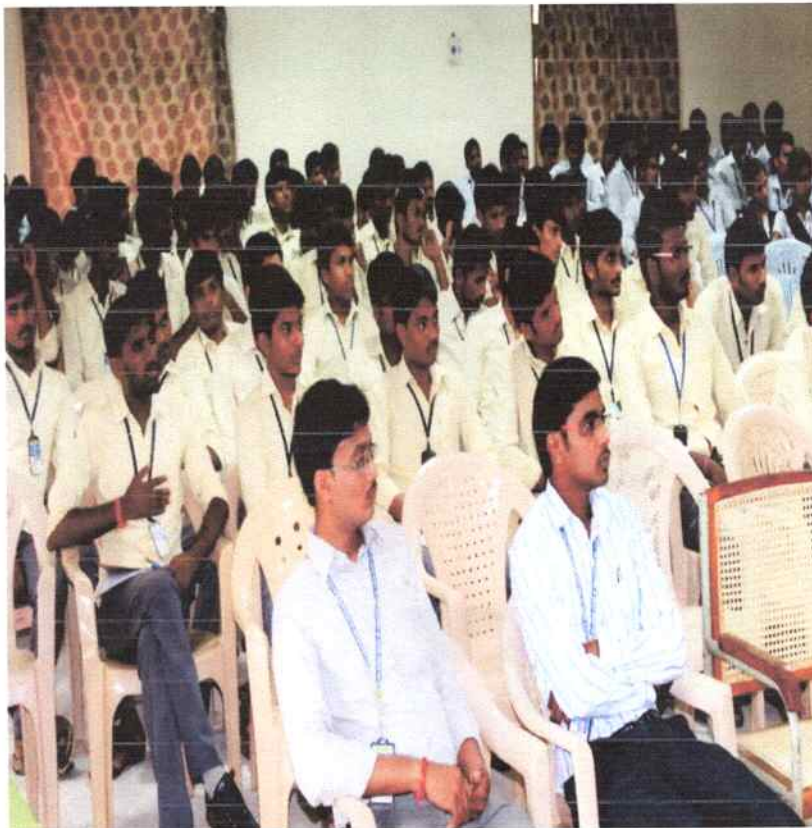
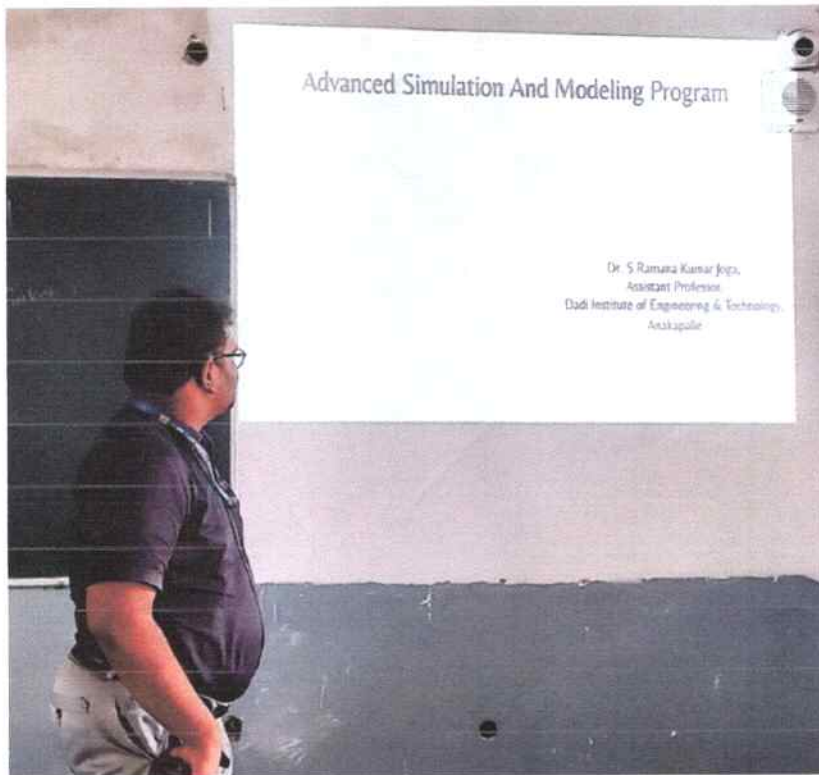

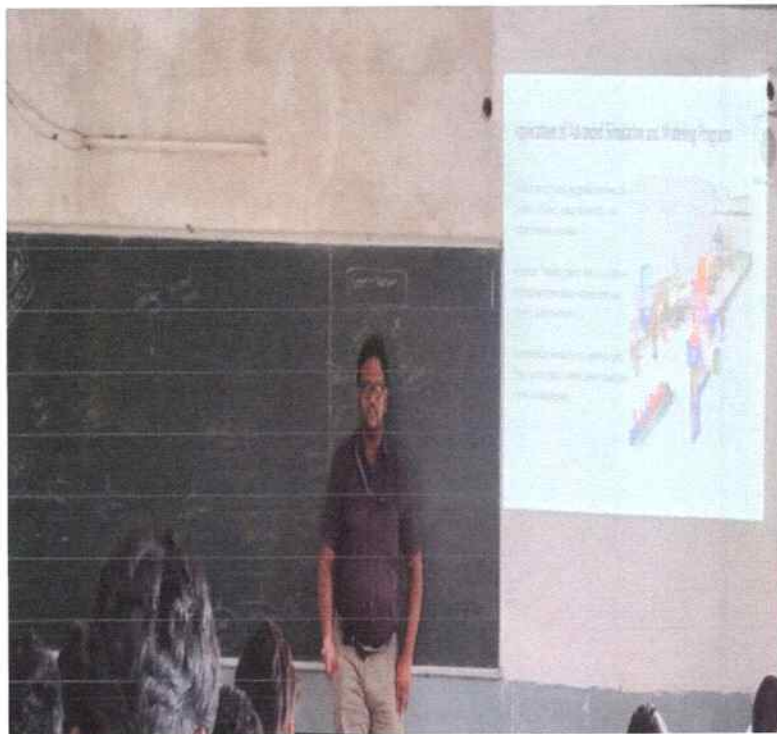
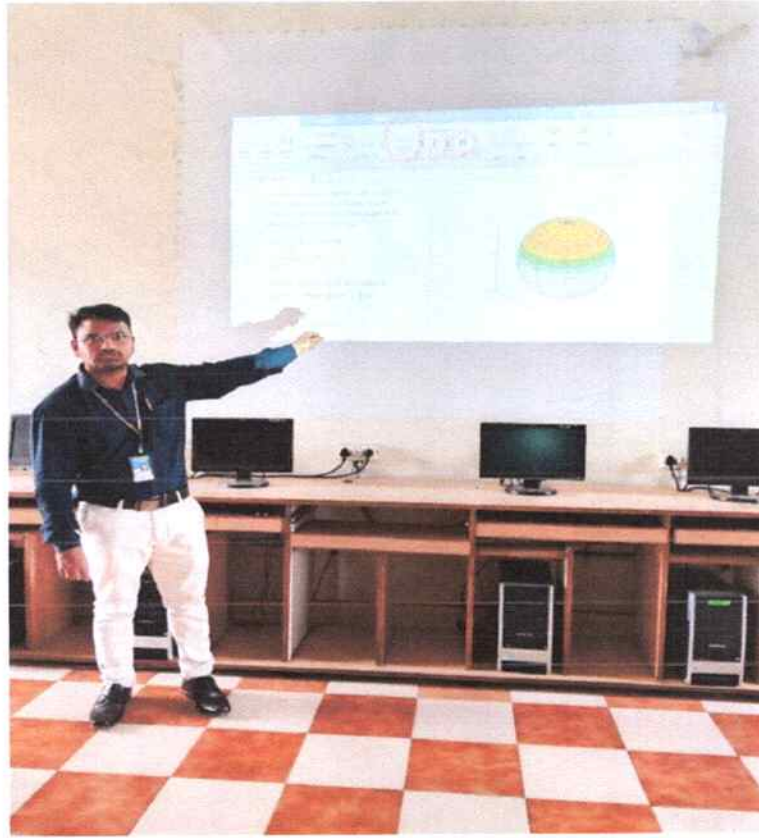



- To equip students with the practical skills necessary to develop and optimize complex simulation models.
- To enhance students' ability to use simulation and modeling as decision-making tools for solving real-world problems.
- To explore the versatility of simulation and modeling in fields such as finance, healthcare, logistics, and more.
- To facilitate networking and collaboration among participants and experts in the field.

**Topics covered:**

1. Introduction to Simulation and Modeling
2. Probability and Statistics in Simulation
3. Monte Carlo Simulation
4. Discrete Event Simulation
5. Agent-Based Modeling
6. Advanced Topics and Applications

**Outcomes of the program:**

At the ending of the program the students will be able to

- Develop and implement advanced simulation models, including Monte Carlo simulations, discrete event simulations, and agent-based models.
- Optimize simulations and interpret results to make informed decisions.
- Apply simulation and modeling techniques to address complex real-world problems in various industries.
- Design and conduct experiments using simulation models to improve processes and systems.
- Collaborate with peers and experts to exchange ideas and best practices in simulation and modeling.

**Number of participants: 32**

  
**Program Co-ordinator**



# SRI SIVANI COLLEGE OF ENGINEERING

(Under the Management of Sri Sivani Educational Society, Srikakulam)

(Approved by AICTE, New Delhi and Affiliated to JNTUGV, Vizianagaram-CC-W6,

UGC Recognition under 2(f) & 12(B), ISO 9001:2015 Certified)

NH-16, CHILAKAPALEM JN., SRIKAKULAM DIST - 532410

## CERTIFICATE OF PARTICIPATION

This is to certify that Mr./Ms. Mandedi Charan Teja bearing rollno 20W61A0203 of III<sup>rd</sup> year I<sup>st</sup> semester has completed A Two Week Add-On program on "Advanced Simulation and Modeling Program" during the period 10-10-2022 to 22-10-2022 organized by the department of Electrical & Electronics Engineering.

  
Co-ordinator

  
HOD

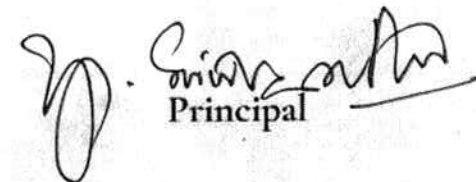
  
Principal





# SRI SIVANI COLLEGE OF ENGINEERING

(Under the Management of Sri Sivani Educational Society, Srikakulam)

(Approved by AICTE, New Delhi and Affiliated to JNTUGV, Vizianagaram-CC-W6,

UGC Recognition under 2(f) & 12(B), ISO 9001:2015 Certified)

NH-16, CHILAKAPALEM JN., SRIKAKULAM DIST - 532410

## CERTIFICATE OF PARTICIPATION

This is to certify that Mr./Ms. Gollapalli. Bharath Kumar bearing rollno 21W65A0208 of III<sup>rd</sup> year I<sup>st</sup> semester has completed A Two Week Add-On program on "Advanced Simulation and Modeling Program" during the period 10-10-2022 to 22-10-2022 organized by the department of Electrical & Electronics Engineering.

  
Co-ordinator

  
HOD

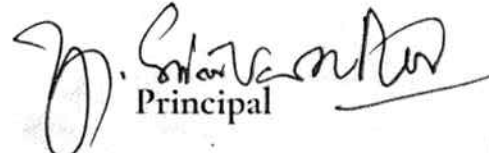
  
Principal



# SRI SIVANI COLLEGE OF ENGINEERING

(Under the Management of Sri Sivani Educational Society, Srikakulam)  
(Approved by AICTE, New Delhi and Affiliated to JNTUGV, Vizianagaram-CC-W6,  
UGC Recognition under 2(f) & 12(B), ISO 9001:2015 Certified)  
NH-16, CHILAKAPALEM JN., SRIKAKULAM DIST - 532410

## CERTIFICATE OF PARTICIPATION

This is to certify that Mr./Ms. Dunga- Prema Kumar bearing rollno 19W61A0201 of IV<sup>th</sup> year I<sup>st</sup> semester has completed A Two Week Add-On program on “Advanced Simulation and Modeling Program” during the period 10-10-2022 to 22-10-2022 organized by the department of Electrical & Electronics Engineering.

  
Co-ordinator

  
HOD

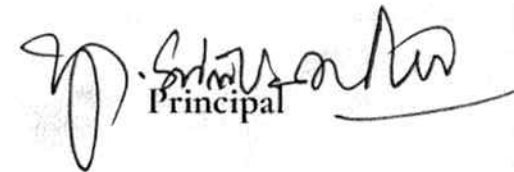
  
Principal





# SRI SIVANI COLLEGE OF ENGINEERING

(Under the Management of Sri Sivani Educational Society, Srikakulam)  
(Approved by AICTE, New Delhi and Affiliated to JNTUGV, Vizianagaram-CC-W6,  
UGC Recognition under 2(f) & 12(B), ISO 9001:2015 Certified)  
NH-16, CHILAKAPALEM JN., SRIKAKULAM DIST -532410

## CERTIFICATE OF PARTICIPATION

This is to certify that Mr./Ms. Grangada Dhilleswara Rao bearing rollno 20W65A0204 of IV<sup>th</sup> year I<sup>st</sup> semester has completed A Two Week Add-On program on "Advanced Simulation and Modeling Program" during the period 10-10-2022 to 22-10-2022 organized by the department of Electrical & Electronics Engineering.

  
Co-ordinator

  
HOD

  
Principal



# SRI SIVANI COLLEGE OF ENGINEERING

(Under the Management of Sri Sivani Educational Society, Srikakulam)  
(Approved by AICTE, New Delhi and Affiliated to JNTUGV, Vizianagaram-CC-W6,  
UGC Recognition under 2(f) & 12(B), ISO 9001:2015 Certified)  
NH-16, CHILAKAPALEM JN., SRIKAKULAM DIST -532410

## CERTIFICATE OF PARTICIPATION

This is to certify that Mr./Ms. Kuna. Santhoshi Kumari bearing rollno 20W65A0205 of IV<sup>th</sup> year I<sup>st</sup> semester has completed A Two Week Add-On program on "Advanced Simulation and Modeling Program" during the period 10-10-2022 to 22-10-2022 organized by the department of Electrical & Electronics Engineering.

  
Co-ordinator

  
HOD

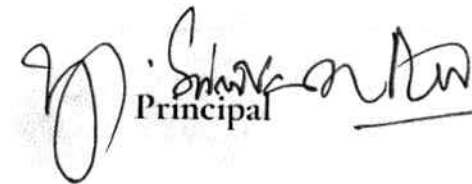
  
Principal





# SRI SIVANI COLLEGE OF ENGINEERING

(Under the Management of Sri Sivani Educational Society, Srikakulam)  
(Approved by AICTE, New Delhi and Affiliated to JNTUGV, Vizianagaram-CC-W6,  
UGC Recognition under 2(f) & 12(B), ISO 9001:2015 Certified)  
NH-16, Chilakapalem Jn., Srikakulam Dist. Andhra Pradesh -532410

Date:04-11-2022

## CIRCULAR







Here by informed that, the Department of Electrical and Electronics Engineering is planning to organize **A Two-week Add-On Program on "ON Grid & OFF Grid Solar Power Generation"** from **14-11-2022** to **26-11-2022** for 2<sup>nd</sup> year EEE students. This program is designed to enhance your skills and expand your knowledge of its applications. In this regard, I suggest all 2<sup>nd</sup> year EEE students should enroll this program on or before **11-11-2022**.

**Venue:**Seminar Hall, Block – 1, SSCE.

**Co-ordinator:** Mr. I. Sai Rajesh Kumar, Asst. Prof,  
Department of Electrical & Electronics Engineering

  
**Principal**  
PRINCIPAL  
SRI SIVANI COLLEGE OF ENGINEERING  
Chilakapalem Jn., SRIKAKULAM

### Copy to

Dept.	IQAC	Civil	EEE	Mech	ECE	CSE	H&BS	MBA	TPO	Office	Library
Signature											

CC To: The Management: for information.



# SRI SIVANI COLLEGE OF ENGINEERING

(Under the Management of Sri Sivani Educational Society, Srikakulam)  
(Approved by AICTE, New Delhi and Affiliated to JNTUGV, Vizianagaram-CC-W6,  
UGC Recognition under 2(f) & 12(B), ISO 9001:2015 Certified)  
NH-16, Chilakapalem Jn., Srikakulam Dist. Andhra Pradesh -532410

## Department of Electrical & Electronics Engineering

Academic Year: 2022-23

Date: 04-11-2022

Name of the program: A Two Week Add-On Program on "ON Grid & OFF Grid Solar  
Power Generation"

### PROGRAM SCHEDULE

S.No	Date	Topics To Be Covered
1	14-11-2022	Introduction to Solar Power Generation
2	15-11-2022	Introduction to Solar Power Generation
3	16-11-2022	Components of Solar Power Systems
4	17-11-2022	Components of Solar Power Systems
5	18-11-2022	Design Considerations for On-Grid Systems
6	19-11-2022	Design Considerations for On-Grid Systems
7	21-11-2022	Design Considerations for Off-Grid Systems
8	22-11-2022	Design Considerations for Off-Grid Systems
9	23-11-2022	Feasibility Analysis and Economic Considerations
10	24-11-2022	Feasibility Analysis and Economic Considerations
11	25-11-2022	Installation and Maintenance
12	26-11-2022	Regulations, Policies, and Future Trends

  
Program Co-ordinator

  
Head of the Department



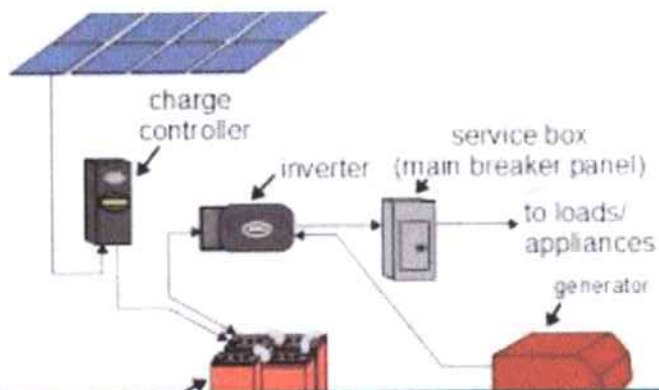

## About Institute

Sri Sivani College of Engineering (SSCE) is one of the colleges functioning under Sri Sivani Educational Society. SSCE is a pioneer in the field of engineering education in Srikakulam district (A.P). It was established in the year 2006 under the affiliation of JNT UGV, Vizianagaram and approved by AICTE, New Delhi. The college is UGC Recognition under 2(f) & 12(B), ISO 9001:2015 Certified) SSCE is situated in a spacious 11 acres campus adjacent to NH-16 at chilkapalem village. The college is easily accessible to all the districts nearby Srikakulam. SSCE offers B.Tech programmes in E.E.E, E.C.E, C.S.E, Mechanical and Civil Engineering, besides PG programmes M.C.A, M.B.A, M.Tech and Diploma programmes like E.E.E, Mechanical, and Civil Engineering as second shift. SSCE is completely Wi-Fi enabled and equipped with well established laboratories. The college has focused towards student centric learning atmosphere. The faculty is well qualified, experienced equipped with state of art technologies and dedicated to produce marketable products.

## About Department

The department is well focused and student centric with clear vision. The department of Electrical and Electronics Engineering is one of the oldest and major departments of the Institute. Since its inception in 2006, the department has been actively engaged in teaching and research in diverse fields of Electrical and Electronics Engineering. The department offers B.Tech in EEE with an intake of 30 students and M.Tech in Power Electronics with an intake of 12 students. The department is strong with a few faculty members holding Ph.D degrees and expertise in various fields. The department of EEE has adequate and well-qualified faculties spanning all major areas of Electrical Engineering like Power Systems, Power Electronics and Control Systems. Apart from regular academics, department organizes department association activities to encourage and motivate the students to achieve their goals. Department also encourages the students to participate in technical events organized by other universities and colleges.

## CHIEF PATRON

Sri. V.M.M. Sainadh Reddy, President,

## PATRONS

Sri. J. Suryachandra Rao, Vice President,  
Sri. K. Durga Srinivas, Secretary,  
Sri. D. Venkata Rao, Treasurer,  
Sri. P. Durga Prasad Raju, Joint Secretary,  
Dr. S. Srinivasa Rao, Correspondent,

## PRINCIPAL

Dr. Y. Srinivas Rao,  
Principal, SSCE

## Head of the Department

Mr. N.Naga Srinivas

## Program Co-ordinator

Mr. I. Sai Rajesh Kumar,

Assistant professor

Mobile: 8897339445

Email: [sairajeshkumar03@gmail.com](mailto:sairajeshkumar03@gmail.com)

## RESOURCE PERSONS

### 1. Dr. C. Rachappa,

Senior Member IEEE,

Divisional Engineer, SCADA Project

TSSPDCL, Hyderabad

### 2. Mr. P. Asish Kumar, M.Tech,

Assistant Professor,

[powerasish4@gmail.com](mailto:powerasish4@gmail.com)

[9346323869](tel:9346323869)

## SRI SIVANI COLLEGE OF ENGINEERING

(Approved by AICTE, New Delhi and Affiliated to JNTUGV, Vizianagaram-CC-W6, UGC Recognition under 2(f) & 12(B), ISO 9001:2015 Certified) NH-16, Chilakapalem Jn., Srikakulam Dist. 532410



## SRI SIVANI COLLEGE OF ENGINEERING

### A TWO -WEEK ADD-ON PROGRAM ON "ON GRID & OFF GRID SOLAR POWER GENERATION"

(14th- 26th November 2022)



Organized by

Department of Electrical &  
Electronics Engineering



## ON GRID SOLAR POWER SYSTEM

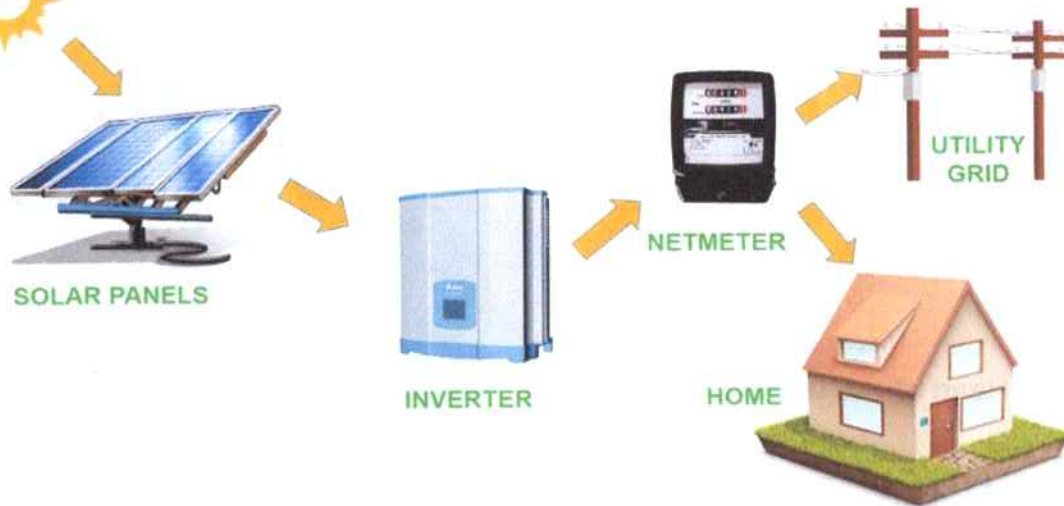

### Objectives

- To provide participants with a comprehensive understanding of on-grid and off-grid solar power systems.
- To familiarize participants with the components, working principles, and design considerations of both on-grid and off-grid solar systems.
- To equip participants with the knowledge to assess the feasibility and benefits of integrating solar power generation into various applications.
- To enable participants to understand the regulatory and policy frameworks related to solar power generation and integration into the grid.
- To empower participants with practical skills to design, install, and maintain on-grid and off-grid solar power systems.

### Program Schedule

- Introduction to Solar Power Generation
- Components of Solar Power Systems
- Design Considerations for On-Grid Systems
- Design Considerations for Off-Grid Systems
- Feasibility Analysis and Economic Considerations
- Installation and Maintenance
- Regulations, Policies, and Future Trends

## REGISTRATION FORM

### A TWO-WEEK ADD-ON PROGRAM ON

### “ON GRID & OFF GRID SOLAR POWER GENERATION”

(14th- 26th November 2022)

Participant's Name :

Gender: Male/Female :

Educational Qualification :

Department :

Organization:

Address for Communication :

Mobile Number :

Email ID :

Date:

Signature of the Participant





# SRI SIVANI COLLEGE OF ENGINEERING

(Under the Management of Sri Sivani Educational Society, Srikakulam)  
(Approved by AICTE, New Delhi and Affiliated to JNTUGV, Vizianagaram-CC-W6,  
UGC Recognition under 2(f) & 12(B), ISO 9001:2015 Certified)  
NH-16, Chilakapalem Jn., Srikakulam Dist. Andhra Pradesh -532410

## Department of Electrical & Electronics Engineering

Academic Year: 2022-23

Date: 09-09-2022

Name of the program: A Two-Week Add-On Program on "ON Grid & OFF Grid Solar  
Power Generation"

### List of Enrolled Students

S.No	Roll Number	Name of the Student	Year-Sem	Signature
1	22W65A0201	Alapana Raju	II-I	A. Raju.
2	22W65A0202	Ankam Chandra Sekhar	II-I	A. Sekhar
3	22W65A0203	Badi Prasanth Kumar	II-I	B. Prasanth Kumar
4	22W65A0204	Baratam Tarun Kumar	II-I	B. Tarun Kumar
5	22W65A0205	Chinnala Vedavathi	II-I	ch. vedavathi
6	22W65A0206	Dandi Nagesh	II-I	D. Nagesh
7	22W65A0207	Darapu Dilleswara Rao	II-I	P. Dilleswararao
8	22W65A0208	Dhilleswararao Dontam	II-I	D. Dilleswararao
9	22W65A0209	Durgasi Rushendra	II-I	D. Rushendra
10	22W65A0210	Gellanki Manohar	II-I	G. Manohar
11	22W65A0211	Gokeda Vasu	II-I	G. Vasu.
12	22W65A0212	Gorle Rajukumar	II-I	G. Rajukumar.
13	22W65A0213	Guggili Bala Muralikrishna	II-I	G. Bala muralikrishna.
14	22W65A0214	Jada Bhargav	II-I	J. Bhargav
15	22W65A0215	Konni Srinu	II-I	K. Srinu
16	22W65A0216	Kovvuru Anil Kumar	II-I	K. Anil Kumar
17	22W65A0217	Landa Manikanta	II-I	L. Manikanta
18	22W65A0218	Manyala Jayanth	II-I	M. Jayanth
19	22W65A0219	Mungi Saisanthosh	II-I	M. Saisanthosh
20	22W65A0220	Muni Manasa	II-I	M. Manasa
21	22W65A0221	Nadiminti Appalanaidu	II-I	N. Appalanaidu
22	22W65A0222	Neteti Lokeswara Rao	II-I	N. Lokesh.
23	22W65A0223	Panga Ravi	II-I	P. Ravi
24	22W65A0224	Pasupureddi Lokanadham	II-I	P. Lokanadham
25	22W65A0225	Patnana Rajasekhar	II-I	P. Rajasekhar
26	22W65A0226	Pitta Sai Kumar	II-I	P. Saikumar
27	22W65A0227	Sheik Abdul	II-I	S. Abdul

28	22W65A0228	Tandra Kiran	II-I	T. Kiran
29	22W65A0229	Ullakula Bhagyasree	II-I	U. Bhagya Sree
30	22W65A0230	Vappangi Harihara Rao	II-I	V. Harihara Rao
31	22W65A0231	Vavilapalli Sandeep	II-I	V. Sandeep
32	22W65A0232	Vepada Jaya Ganesh	II-I	V. Jaya Ganesh
33	22W65A0233	Jamana Ravi	II-I	J. Ravi

  
Program Co-ordinator

  
Head of the Department





22	22W65A0222	Neteti Lokeswara Rao	P	P	P	P	P	P	P	P	P	P	P	P
23	22W65A0223	Panga Ravi	P	P	P	P	P	P	P	P	P	P	P	P
24	22W65A0224	Pasupureddi Lokanadham	P	P	AB	P	P	P	P	P	P	P	P	P
25	22W65A0225	P Rajasekhar	P	P	P	P	P	P	P	P	P	P	P	P
26	22W65A0226	Pitta Sai Kumar	P	P	P	P	P	P	P	P	P	P	P	P
27	22W65A0227	Sheik Abdul	P	P	P	P	P	P	AB	P	P	P	P	P
28	22W65A0228	Tandra Kiran	P	P	P	P	P	P	P	P	P	P	P	P
29	22W65A0229	Ullakula Bhagyasree	P	P	P	P	P	P	P	P	P	P	P	P
30	22W65A0230	Vappangi Harihara Rao	P	P	P	P	P	P	P	P	P	P	P	P
31	22W65A0231	Vavilapalli Sandeep	P	P	P	P	P	P	P	P	P	P	P	P
32	22W65A0232	Vepada Jaya Ganesh	P	P	P	P	P	P	P	P	P	AB	P	P
33	22W65A0233	Jamana Ravi	P	AB	P	P	P	P	P	P	P	P	P	P
Signature :			P	P	P	P	P	P	P	P	P	P	P	P

  
**Program Co-ordinator**





# SRI SIVANI COLLEGE OF ENGINEERING

(Under the Management of Sri Sivani Educational Society, Srikakulam)  
(Approved by AICTE, New Delhi and Affiliated to JNTUGV, Vizianagaram-CC-W6,  
UGC Recognition under 2(f) & 12(B), ISO 9001:2015 Certified)  
NH-16, Chilakapalem Jn., Srikakulam Dist. Andhra Pradesh -532410

## Department of Electrical & Electronics Engineering

Academic year: 2022-23

Date: 29-11-2022

### PROGRAM REPORT

- Name of the Program** : A Two-Week Add-On Program on “ON Grid & OFF Grid Solar Power Generation”
- Duration of the Program** : 14-11-2022 to 26-11-2022
- Details of Resource Persons** : 1. Dr. C. Rachappa, M. Tech, PGPM  
Member of IEEE,  
Divisional Engineer,  
SCADA / TSCPDCL / HYDERABAD.  
2. Mr. P. Asish Kumar, M .Tech,  
Assistant Professor,  
Dept. of EEE,  
Sri Sivani College of Engineering  
[powerasish4@gmail.com](mailto:powerasish4@gmail.com)  
9346323869
- Details of Program Co-ordinator** : Mr. I. Sai Rajesh Kumar, M .Tech,  
Assistant Professor,  
Dept. of EEE,  
Sri Sivani College of Engineering  
[Sairajeshkumar03@gmail.com](mailto:Sairajeshkumar03@gmail.com)  
8897339445

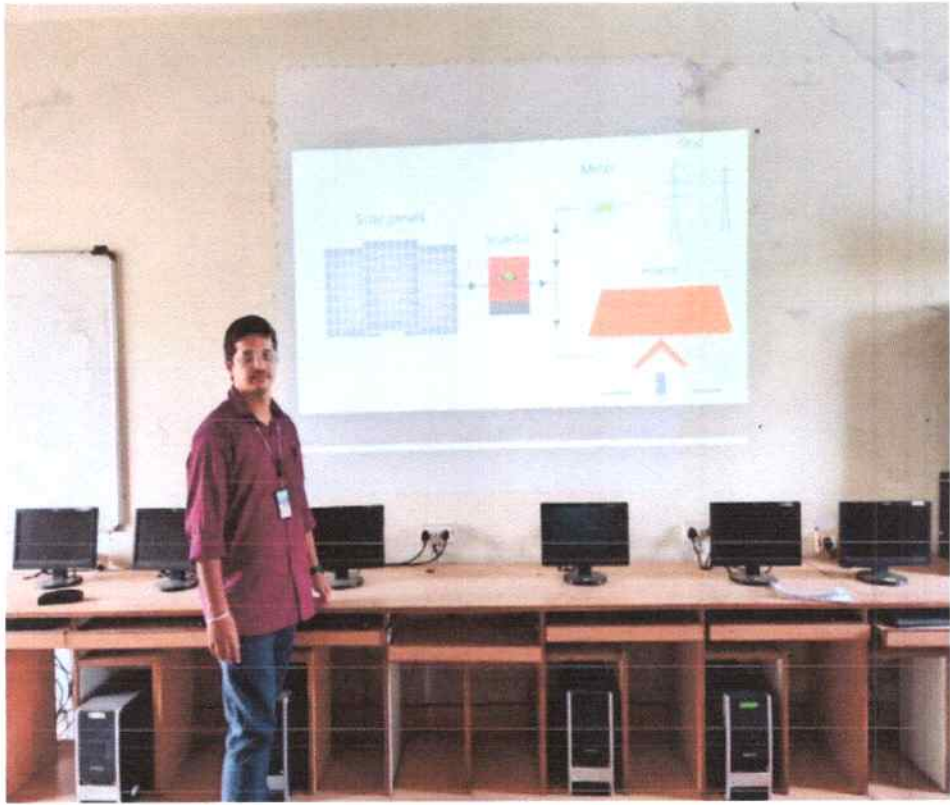



**Objectives of the program:**

- To provide participants with a comprehensive understanding of on-grid and off-grid solar power systems.
- To familiarize participants with the components, working principles, and design considerations of both on-grid and off-grid solar systems.
- To equip participants with the knowledge to assess the feasibility and benefits of integrating solar power generation into various applications.
- To enable participants to understand the regulatory and policy frameworks related to solar power generation and integration into the grid.
- To empower participants with practical skills to design, install, and maintain on-grid and off-grid solar power systems.

**Topics covered:**

- Introduction to solar power generation.
- Components of solar power generation.
- Design considerations for On-Grid systems.
- Design considerations for Off-Grid systems.
- Feasibility analysis and economic considerations.
- Installation and maintenance.
- Regulations, policies, and future trends

**Outcomes of the program:**

At the ending of the program the students will be able to

- Differentiate between on-grid and off-grid solar power systems and explain their advantages and disadvantages.
- Identify the key components of solar power systems, including solar panels, inverters, batteries, and charge controllers.
- Analyze energy consumption patterns and solar resource availability to determine the appropriate system size and configuration for specific applications.

- Evaluate the economic and environmental benefits of solar power integration, considering factors like payback period, return on investment, and carbon footprint reduction.
- Interpret relevant regulations, policies, and incentives related to solar power generation and grid connection.
- Plan and design on-grid and off-grid solar power systems, considering factors such as load requirements, site conditions, and safety considerations.
- Demonstrate practical skills in installing solar panels, configuring inverters, and setting up battery storage for both on-grid and off-grid systems.
- Troubleshoot common issues in solar power systems and perform basic maintenance to ensure optimal performance

**Number of participants : 33**

  
**Program Co-ordinator**





# SRI SIVANI COLLEGE OF ENGINEERING

(Under the Management of Sri Sivani Educational Society, Srikakulam)  
(Approved by AICTE, New Delhi and Affiliated to JNTUGV, Vizianagaram-CC W6,  
UGC Recognition under 2(f) & 12(B), ISO 9001:2015 Certified)  
NH-16, CHILAKAPALEM JN., SRIKAKULAM DIST - 532410

## CERTIFICATE OF PARTICIPATION

This is to certify that Mr./Ms. Baratam. Tarun Kumar bearing  
roll no 22W65A0204 of II<sup>nd</sup> year I<sup>st</sup> semester has completed A Two Week  
Add-On program on “**ON Grid & OFF Grid Solar Power Generation**” during the period **14-11-2022** to  
**26-11-2022** organized by the department of Electrical & Electronics Engineering.

  
CO-ORDINATOR

  
HOD

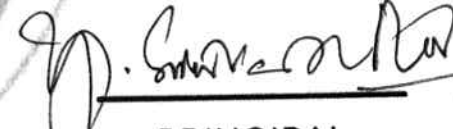
  
PRINCIPAL



# SRI SIVANI COLLEGE OF ENGINEERING

(Under the Management of Sri Sivani Educational Society, Srikakulam)  
(Approved by AICTE, New Delhi and Affiliated to JNTUGV, Vizianagaram CC-W6,  
UGC Recognition under 2(f) & 12(B), ISO 9001:2015 Certified)  
NH-16, CHILAKAPALEM JN., SRIKAKULAM DIST - 532410

## CERTIFICATE OF PARTICIPATION

This is to certify that Mr./Ms. Muni. Manasa bearing  
roll no 22WG5A0220 of II<sup>nd</sup> year I<sup>st</sup> semester has completed A Two Week  
Add-On program on “**ON Grid & OFF Grid Solar Power Generation**” during the period **14-11-2022** to  
**26-11-2022** organized by the department of Electrical & Electronics Engineering.

  
CO-ORDINATOR

  
HOD

  
PRINCIPAL





# SRI SIVANI COLLEGE OF ENGINEERING

(Under the Management of Sri Sivani Educational Society, Srikakulam)  
(Approved by AICTE, New Delhi and Affiliated to JNTUGV, Vizianagaram CC-W6,  
UGC Recognition under 2(f) & 12(B), ISO 9001:2015 Certified)  
NH-16, CHILAKAPALEM JN., SRIKAKULAM DIST-532410

## CERTIFICATE OF PARTICIPATION

This is to certify that Mr./Ms. Ullakula. Bhagyasree bearing  
roll no 22W65A0229 of II<sup>nd</sup> year I<sup>st</sup> semester has completed A Two Week  
Add-On program on “**ON Grid & OFF Grid Solar Power Generation**” during the period **14-11-2022** to  
**26-11-2022** organized by the department of Electrical & Electronics Engineering.

  
CO-ORDINATOR

  
HOD

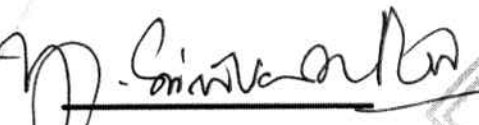
  
PRINCIPAL



# SRI SIVANI COLLEGE OF ENGINEERING

(Under the Management of Sri Sivani Educational Society, Srikakulam)  
(Approved by AICTE, New Delhi and Affiliated to JNTUGV, Vizianagaram-CC-W6,  
UGC Recognition under 2(f) & 12(B), ISO 9001:2015 Certified)  
NH 16, CHILAKAPALEM JN., SRIKAKULAM DIST -532410

## CERTIFICATE OF PARTICIPATION

This is to certify that Mr./Ms. Vavilapalli Sandeep bearing  
roll no 22W65A0231 of II<sup>nd</sup> year I<sup>st</sup> semester has completed A Two Week  
Add-On program on "**ON Grid & OFF Grid Solar Power Generation**" during the period **14-11-2022** to  
**26-11-2022** organized by the department of Electrical & Electronics Engineering.

  
\_\_\_\_\_  
CO-ORDINATOR

  
\_\_\_\_\_  
HOD

  
\_\_\_\_\_  
PRINCIPAL





# SRI SIVANI COLLEGE OF ENGINEERING

(Under the Management of Sri Sivani Educational Society, Srikakulam)  
(Approved by AICTE, New Delhi and Affiliated to JNTUGV, Vizianagaram CC-W6,  
UGC Recognition under 2(f) & 12(B), ISO 9001:2015 Certified)  
NH-16, CHILAKAPALEM JN., SRIKAKULAM DIST-532410

## CERTIFICATE OF PARTICIPATION

This is to certify that Mr./Ms. Jamana . Ravi bearing  
roll no 22WG5A0233 of II<sup>nd</sup> year I<sup>st</sup> semester has completed A Two Week  
Add-On program on “**ON Grid & OFF Grid Solar Power Generation**” during the period **14-11-2022** to  
**26-11-2022** organized by the department of Electrical & Electronics Engineering.

  
CO-ORDINATOR

  
HOD

  
PRINCIPAL



# SRI SIVANI COLLEGE OF ENGINEERING

(Under the Management of Sri Sivani Educational Society, Srikakulam)  
(Approved by AICTE, New Delhi and Affiliated to JNTUGV, Vizianagaram-CC-W6,  
UGC Recognition under 2(f) & 12(B), ISO 9001:2015 Certified)  
NH-16, Chilakapalem Jn., Srikakulam Dist. Andhra Pradesh -532410

Date: 26-11-2022

## CIRCULAR

This is to inform that the Department of Computer Science Engineering is organizing **A Two Week Add-On Program on “Web Development Using DJANGO”** during **05-12-2022 to 17-12-2022** to the 1<sup>st</sup> and 2<sup>nd</sup> year CSE, ECE and EEE M.Tech students to enhance their skills applicable for job opportunities. Built by experienced developers, DJANGO takes care of much of the hassle of web development, so you can focus on writing your app without needing to reinvent the wheel. In this regard, I suggest all the students to enroll for this course on or before 30 November 2022.

**Venue** : VLSI Lab, Block – 2, SSCE.

**Co-ordinator:** Mrs. K.SAKUNTHALA, Asst. Prof,  
Department of Computer Science Engineering

**Principal**

PRINCIPAL  
SRI SIVANI COLLEGE OF ENGINEERING  
Chilakapalem Jn., SRIKAKULAM

### Copy to

Dept.	IQAC	Civil	EEE	MECH	ECE	CSE	H&BS	MBA	TPO	Office	Library
Signature											

CC To: The Management: for information.





# SRI SIVANI COLLEGE OF ENGINEERING

(Under the Management of Sri Sivani Educational Society, Srikakulam)  
(Approved by AICTE, New Delhi and Affiliated to JNTUGV, Vizianagaram-CC-W6,  
UGC Recognition under 2(f) & 12(B), ISO 9001:2015 Certified)  
NH-16, Chilakapalem Jn., Srikakulam Dist. Andhra Pradesh -532410

## Department of Computer Science Engineering

Academic Year : 2022-23

Date: 26-11-2022

Name of the Program: A Two Week Add-on Program on Web Development Using DJANGO

### PROGRAM SCHEDULE

S.NO	DATE	TOPICS TO BE COVERED
1	05-12-2022	Introduction on python, Installation of python, How to use python, Python Basic Syntax, Python
2	06-12-2022	Literals, Constants & variables, Keywords, Operators, Comments
3	07-12-2022	Control flow statement Data structure (List, Tuple & dictionary in python)
4	08-12-2022	Function, Module & Packages Array Numpy
5	09-12-2022	Basic OOPS Concept-1 SQL and python-1 SQL and python-2
6	10-12-2022	Concepts of Web Page-1 Concepts of Web Page-2
7	12-12-2022	Introduction on DJANGO, DJANGO Project & server configuration
8	13-12-2022	DJANGO app, MVT Design Pattern View, Template, URL Mapping, Static file Handling
9	14-12-2022	Model Form, DJANGO Form, Form Validation File Upload, Database connectivity
10	15-12-2022	Creating CURD application in Django Django Middleware, Session & cookies
11	16-12-2022	Introduction to Flask Name of Course Coordinator
12	17-12-2022	Applications of DJANGO

  
Program Co-ordinator

  
Head of the Department



## ABOUT THE INSTITUTION

Sri Sivani College of Engineering (SSCE) is one of the colleges functioning under Sri Sivani Educational Society, established in 2006 affiliated to JNTUGV, Vizianagaram. UGC Recognition under 2(f) & 12(B). ISO 9001:2015 Certified. SSCE is situated in a spacious 12 acres campus adjacent to NH-16 at Chilakapalem, Srikakulam, Andhra Pradesh. SSCE offers B. Tech programs in Civil, C.S.E, E.E.E, E.C.E, Mechanical Engineering and PG programmes M.B.A, M.Tech and Diploma programmes for Civil, E.E.E and Mechanical Engineering. Fully connected through Fiber Optics and Wi-Fi Networks. Endowed with fully Qualified, well experienced and seasoned faculty members equipped with industrial experience and fully established laboratories with state-of-the-art technologies meets the growing needs of the students.

## ABOUT THE DEPARTMENT

The Department of Computer Science Engineering of Sri Sivani College of Engineering was established in the year 2006 and playing a vital role in designing, developing maintaining software and hardware for the entire college. It has been offering full time B. Tech (CSE), M. Tech (CSE) courses. The Department has been advancing at a rapid pace with the acquisition of advanced facilities and dedicated teaching faculty to properly motivate and mould the students for a better and prospective tomorrow. The Department is adequately equipped with several full fledged computer laboratories and research groups in order to enhance R & D and consultancy. CSE Department Laboratories are well equipped with Dual Core clients running on Windows and Fedora Operating Servers, Oracle Servers and Xeon servers with all licensed software's. The systems are connected through 100/1000 Mbps CAT 5 UTP cabling and fiber connectivity, high-end routers and switches of 40Mbps internet facility with LAN and Wi-Fi. The laboratories are established with an objective to promote practical knowledge in latest cutting-edge technologies, research and consultancy work.

## PATRONS

Sri. V.M.M. Sainadh Reddy, President,  
Sri. J. Suryachandra Rao, Vice President,  
Sri. K. Durga Srinivas, Secretary,  
Sri. D. Venkata Rao, Treasurer,  
Sri. P. Durga Prasad Raju, Joint Secretary,  
Dr.S. Srinivasa Rao, Correspondent,



## CHAIRMAN

**Dr. Y. Srinivasa Rao,**  
Principal, SSCE

## ORGANISING COMMITTEE

**Mr.M.Murali Krishna**  
Head of the Department  
Program Co-ordinator

Mrs. KSAKUNTHALA, Assistant professor  
Mobile: 9505089127  
Email: sasigmr@gmail.com

## SRI SIVANI COLLEGE OF ENGINEERING

(Under the Management of Sri Sivani Educational Society, Srikakulam)

(Approved by AICTE, New Delhi and Affiliated to JNTUGV, Vizianagaram-CC-W6)

UGC Recognition under 2(f) & 12(B), ISO 9001:2015 Certified) NH-16, Chilakapalem Jn., Srikakulam Dist. Andhra Pradesh -532410

## SRI SIVANI COLLEGE OF ENGINEERING

### A Two-Week Add-On Program on "Web Development Using DJANGO"

Benefits and Features of

**Django**

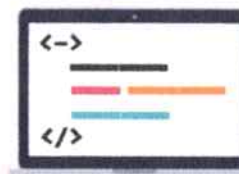

05-12-2022 to 17-12-2022

ORGANIZED BY

DEPARTMENT OF COMPUTER SCIENCE  
ENGINEERING





### Objectives of the program:

This course, students will learn about the most advanced Web-app development environments with immense exposure on practicality.

The course is designed for an aspiring developer to enrich the knowledge of different Web based Python Frameworks.

In this curriculum, we have covered Python fundamentals including OOPS concepts.

The course has been designed in such a way that a candidate can handle both the Frontend and Back-end development processes. My SQL is also covered to connect our application with the Database.

### Resource Person

Mr.J.Chiranjeevi,M.Tech  
chiranjeevi.jami@gmail.com  
9885385229,SSCE

### PROGRAM CONTENT

- Introduction on python, Installation of python, How to use python, Python Basic Syntax, Python
- Literals, Constants & variables, Keywords, Operators, Comments
- Control flow statement Data structure (List, Tuple & dictionary in python)
- Function, Module & Packages Array Numpy
- Basic OOPS Concept-1 SQL and python-1 SQL and python-2
- Concepts of Web Page-1 Concepts of Web Page-2
- Introduction on DJANGO, DJANGO Project & server configuration
- DJANGO app, MVT Design Pattern View, Template, URL Mapping, Static file Handling
- Model Form, DJANGO Form, Form Validation File Upload, Database connectivity
- Creating CURD application in Django Django Middleware, Session & cookies
- Introduction to Flask Name of Course Coordinator

### REGISTRATION FORM

### A TWO -WEEK ADD-ON PROGRAM ON "WEB DEVELOPMENT USING DJANGO"

Participant's Name:

Gender: Male/Female

Educational Qualifications:

Department:

Organization:

Address for Communication:

Phone No:

Email:

Date:

Signature of the Participant:







# SRI SIVANI COLLEGE OF ENGINEERING

(Under the Management of Sri Sivani Educational Society, Srikakulam)  
(Approved by AICTE, New Delhi and Affiliated to JNTUGV, Vizianagaram-CC-W6,  
UGC Recognition under 2(f) & 12(B), ISO 9001:2015 Certified)  
NH-16, Chilakapalem Jn., Srikakulam Dist. Andhra Pradesh -532410

## Department of Computer Science Engineering

Academic Year : 2022-23

DATE: 05-12-2022

Name of the Program: A Two Week Add-On Program on Web Development Using DJANGO

### List of Enrolled Students

S.NO	ROOL NO	NAME OF THE STUDENT	YEAR-SEM	SIGNATURE
1	21W61D4301	Gedala Srinivasa Reddy	II-I	G. Srinivasa Reddy
2	21W61D4302	Meraka Dinesh	II-I	M. Dinesh
3	21W61D4303	Meraka Mounika	II-I	M. Mounika
4	21W61D5701	Singuru Santhoshkumar	II-I	S. Santhoshkumar
5	21W61D5702	Menda Jyothsna Devi	II-I	M. Jyothsna Devi
6	21W61D5703	T. Sekhar Gorripotu	II-I	T. Sekhar Gorripotu
7	21W61D5802	Naga Srinivas Nakka	II-I	N. Srinivas
8	21W61D5803	Thottadi Lakshmi Prasanna	II-I	T. LAKSHMI PRASANNA
9	21W61D5805	Mediseti Sri Sarika	II-I	M. Sarika
10	21W61D5806	Majji Meenakshi	II-I	M. Meenakshi
11	22W61D5801	Lugalapu Prasad Rao	I-I	L. Prasad Rao
12	22W61D5802	M Kalpana	I-I	M. Kalpana
13	22W61D5803	Pragada Ajay Kumar	I-I	P. Ajay Kumar
14	22W61D5804	Rahul S N V S S Kandula	I-I	R. S. Kandula
15	22W61D5805	Savara Raju	I-I	S. Raju

Program Co-ordinator

Head of the Department





# SRI SIVANI COLLEGE OF ENGINEERING

(Under the Management of Sri Sivani Educational Society, Srikakulam)  
(Approved by AICTE, New Delhi and Affiliated to JNTUGV, Vizianagaram-CC-W6,  
UGC Recognition under 2(f) & 12(B), ISO 9001:2015 Certified)  
NH-16, Chilakapalem Jn., Srikakulam Dist. Andhra Pradesh -532410

## Department of Computer Science Engineering

Academic Year : 2022-23

Name of the Program: A Two Week Add-On Program on Web Development Using DJANGO

### DAY WISE ATTENDANCE SHEET

S.NO	ROOL NO	NAME OF THE STUDENT	1	2	3	4	5	6	7	8	9	10	11	12
			$\frac{5}{12}$	$\frac{6}{12}$	$\frac{7}{12}$	$\frac{8}{12}$	$\frac{9}{12}$	$\frac{10}{12}$	$\frac{12}{12}$	$\frac{13}{12}$	$\frac{14}{12}$	$\frac{15}{12}$	$\frac{16}{12}$	$\frac{17}{12}$
1	21W61D4301	G.Srinivasa Reddy	P	P	P	P	P	P	P	P	P	P	P	P
2	21W61D4302	Meraka Dinesh	P	P	P	P	P	P	P	P	P	AB	P	P
3	21W61D4303	Meraka Mounika	P	P	P	P	P	P	P	AB	P	P	P	P
4	21W61D5701	S.Santhoshkumar	P	P	P	P	P	P	P	P	P	P	P	P
5	21W61D5702	Menda Jyothsna Devi	P	P	P	P	P	P	P	P	P	P	P	P
6	21W61D5703	T. Sekhar Gorripotu	P	P	P	AB	P	P	P	P	P	P	P	P
7	21W61D5802	Naga Srinivas Nakka	P	P	P	P	P	P	P	P	P	P	P	P
8	21W61D5803	T. Lakshmi Prasanna	P	P	P	P	P	P	P	P	P	P	P	P
9	21W61D5805	Mediseti Sri Sarika	P	P	P	P	P	P	P	P	AB	P	P	P
10	21W61D5806	Majji Meenakshi	P	P	P	P	P	P	P	P	P	P	P	P
11	22W61D5801	Lugalapu Prasad Rao	P	P	P	P	P	P	P	P	P	P	P	P
12	22W61D5802	M Kalpana	P	P	P	AB	P	P	P	P	P	P	P	P
13	22W61D5803	Pragada Ajay Kumar	P	P	P	P	P	P	P	P	P	P	P	P
14	22W61D5804	Rahul S N V S S	P	P	P	P	P	P	AB	P	P	P	P	P
15	22W61D5805	Savara Raju	P	P	P	P	P	P	P	P	P	P	P	P

  
Program Co-ordinator

  
Head of the Department



# SRI SIVANI COLLEGE OF ENGINEERING

(Under the Management of Sri Sivani Educational Society, Srikakulam)  
(Approved by AICTE, New Delhi and Affiliated to JNTUGV, Vizianagaram-CC-W6,  
UGC Recognition under 2(f) & 12(B), ISO 9001:2015 Certified)  
NH-16, Chilakapalem Jn., Srikakulam Dist. Andhra Pradesh -532410

## Department of Computer Science Engineering

Academic Year: 2022-23

DATE: 19-12-2022

### PROGRAM REPORT

**Name of the Program** : A Two Week Add-On Program on **Web Development Using DJANGO**

**Program Duration** : **05-12-2022 to 17-12-2022**

**Name of the Resource Person & Details:** Mr.JAMI.CHIRANJEEVI, M.Tech

Assistant Professor

Dept. of CSE, chiranjeevi.jami@gmail.com

9885385229

**Details of the Program Coordinator** : Mrs.K.SAKUNTHALA, M.Tech

Assistant Professor,

Dept. of CSE, sasigmr@gmail.com

9505089127

#### **Objectives of the program:**

- This course, students will learn about the most advanced Web-app development environments with immense exposure on practicality.
- The course is designed for an aspiring developer to enrich the knowledge of different Web based Python Frameworks.
- In this curriculum, we have covered Python fundamentals including OOPS concepts.
- The course has been designed in such a way that a candidate can handle both the Frontend and Back-end development processes. My SQL is also covered to connect our application with the Database.



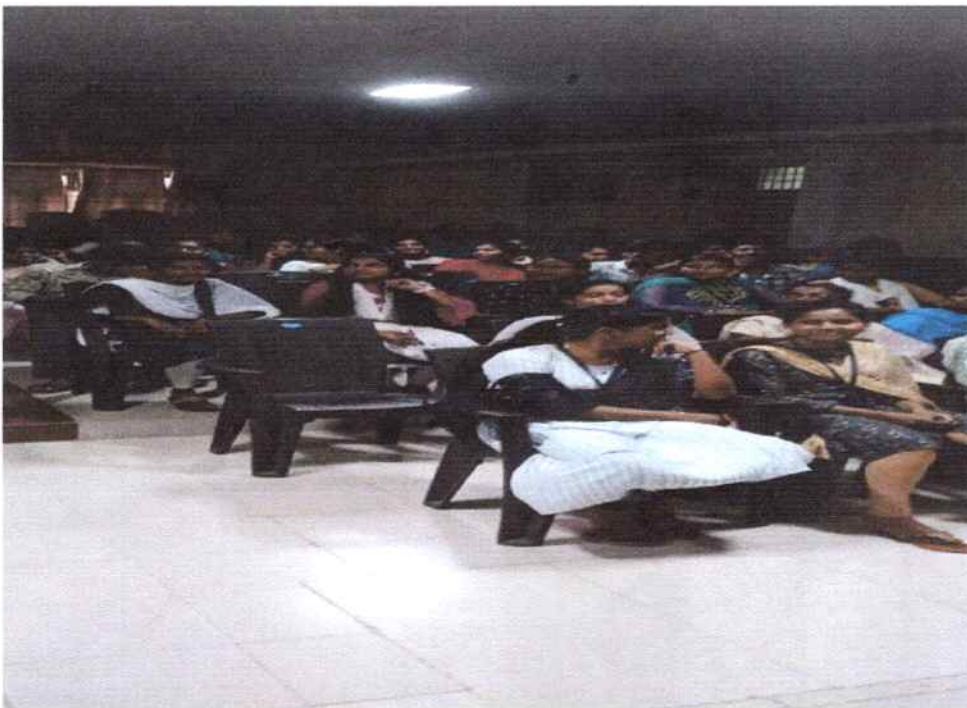
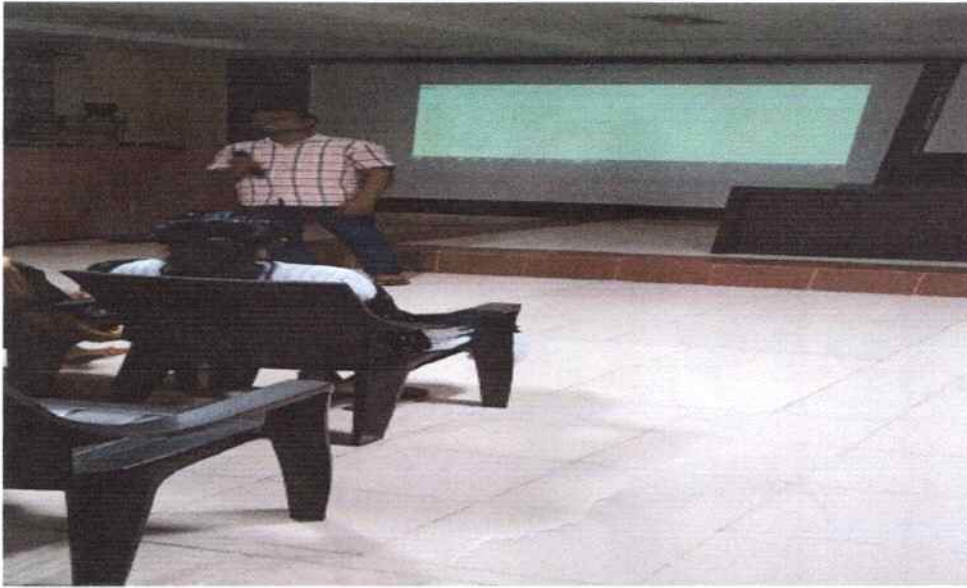

**Topics covered:**

- Introduction on python, Installation of python, How to use python, Python Basic Syntax, Python
- Literals, Constants & variables, Keywords, Operators, Comments
- Control flow statement Data structure (List, Tuple & dictionary in python)
- Function, Module & Packages Array Numpy
- Basic OOPS Concept-1 SQL and python-1 SQL and python-2

- Concepts of Web Page-1 Concepts of Web Page-2
- Introduction on DJANGO, DJANGO Project & server configuration
- DJANGO app, MVT Design Pattern View, Template, URL Mapping, Static file Handling
- Model Form, DJANGO Form, Form Validation File Upload, Database connectivity
- Creating CURD application in DJANGO, DJANGO Middleware, Session & cookies
- Introduction to Flask Name of Course Coordinator

**Outcomes of the program:**

- How to create routes (or views) with DJANGO.
- How to serve static content and files using DJANGO.
- How to connect templates with models to serve data dynamically.
- How to create Models and how to connect them with Templates and Views.
- How to work with databases using SQLite.

**Number of Participants: 15**



**Program Co-ordinator**





## SRI SIVANI COLLEGE OF ENGINEERING

(Under the Management of Sri Sivani Educational Society, Srikakulam)  
(Approved by AICTE, New Delhi and Affiliated to JNTUGV, Vizianagaram-CC-W6,  
UGC Recognition under 2(f) & 12(B), ISO 9001:2015 Certified)  
NH-16, Chilakapalem Jn., Srikakulam Dist. Andhra Pradesh -532410

### CERTIFICATE OF PARTICIPATION

This is to certify that Mr./Ms. P. AJAY KUMAR  
bearing Roll no 2266105803 of I Year I Semester has completed A  
Two Week Add-On Program on “**Web Development Using DJANGO**” during the period  
**05-12-2022 to 17-12-2022** organized by Department of Computer Science Engineering.

  
Co-ordinator

  
HOD

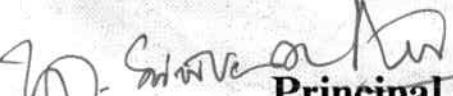
  
Principal



## SRI SIVANI COLLEGE OF ENGINEERING

(Under the Management of Sri Sivani Educational Society, Srikakulam)  
(Approved by AICTE, New Delhi and Affiliated to JNTUGV, Vizianagaram-CC-W6,  
UGC Recognition under 2(f) & 12(B), ISO 9001:2015 Certified)  
NH-16, Chilakapalem Jn., Srikakulam Dist. Andhra Pradesh -532410

### CERTIFICATE OF PARTICIPATION

This is to certify that **Mr./Ms.** M. MOONIKA  
bearing Roll no 21UG1D4303 of II Year I Semester has completed A  
Two Week Add-On Program on “**Web Development Using DJANGO**” during the period  
**05-12-2022 to 17-12-2022** organized by Department of Computer Science Engineering.

  
Co-ordinator

  
HOD

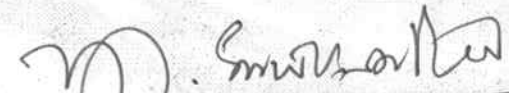
  
Principal





## SRI SIVANI COLLEGE OF ENGINEERING

(Under the Management of Sri Sivani Educational Society, Srikakulam)  
(Approved by AICTE, New Delhi and Affiliated to JNTUGV, Vizianagaram-CC-W6,  
UGC Recognition under 2(f) & 12(B), ISO 9001:2015 Certified)  
NH-16, Chilakapalem Jn., Srikakulam Dist. Andhra Pradesh -532410

### CERTIFICATE OF PARTICIPATION

This is to certify that Mr./~~Ms.~~ M. DINESH  
bearing Roll no 21N6104302 of II Year I Semester has completed A  
Two Week Add-On Program on “**Web Development Using DJANGO**” during the period  
**05-12-2022 to 17-12-2022** organized by Department of Computer Science Engineering.

  
Co-ordinator

  
HOD

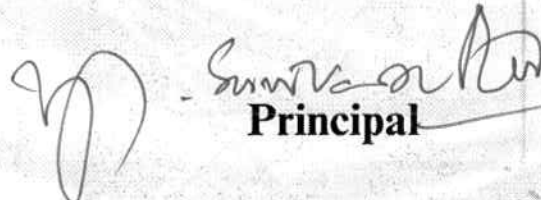
  
Principal



# SRI SIVANI COLLEGE OF ENGINEERING

(Under the Management of Sri Sivani Educational Society, Srikakulam)  
(Approved by AICTE, New Delhi and Affiliated to JNTUGV, Vizianagaram-CC-W6,  
UGC Recognition under 2(f) & 12(B), ISO 9001:2015 Certified)  
NH-16, Chilakapalem Jn., Srikakulam Dist -532410

Date: 08-12-2022

## CIRCULAR

Here by informed to all the 1<sup>st</sup> year CSE, CIVIL and MECH students that, the Department of Humanities and Basics Science is planning to organize **A Two-week ADD-ON Program on "Fuels"** from **15-12-2022** to **28-12-2022**. This program is aimed at enhancing your skills and knowledge. In this regard, I suggest all students should enroll this program on or before **12-12-2022**.







**Venue:** Seminar Hall, Block – 1, SSCE.

**Co-ordinator:** Mr. K Madhukumar, Assoc. Prof,

Department of Humanities and Basics Sciences

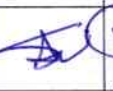
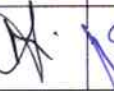
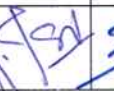
  
**Principal**  
PRINCIPAL  
SRI SIVANI COLLEGE OF ENGINEERING  
Chilakapalem Jn., SRIKAKULAM

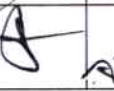
Copy to

Dept.	IQAC	Civil	EEE	Mech	ECE	CSE	H&BS	MBA	TPO	Office	Library
Signature											

CC To: The Management: for information.





# SRI SIVANI COLLEGE OF ENGINEERING

(Under the Management of Sri Sivani Educational Society, Srikakulam)  
(Approved by AICTE, New Delhi and Affiliated to JNTUGV, Vizianagaram-CC-W6,  
UGC Recognition under 2(f) & 12(B), ISO 9001:2015 Certified)  
NH-16, Chilakapalem Jn., Srikakulam Dist -532410

## DEPARTMENT OF HUMANITIES & BASIC SCIENCES

Academic Year : 2022-23

Date: 08-12-2022

Name of the program: A Two-week Add-On Program on "Fuels"

### PROGRAM SCHEDULE

S.No	Date	Topics To Be Covered
1	15-12-2022	Introduction
2	16-12-2022	Classifications of fuels
3	17-12-2022	Characteristics of good fuel
4	19-2-2022	Unit of heat
5	20-12-2022	Calorific Value
6	21-12-2022	Gross Calorific value
7	22-12-2022	Net Calorific value
8	23-12-2022	Determination of Calorific value
9	24-12-2022	Analysis of coal
10	26-12-2022	Ultimate analysis
11	27-12-2022	Proximate analysis
12	28-12-2022	Biogas

  
Program Co-ordinator

  
Head of the Department

## ABOUT THE INSTITUTION

Sri Sivani College of Engineering (SSCE) is one of the colleges functioning under Sri Sivani Educational Society. SSCE is a pioneer in the field of engineering education in Srikakulam district (A.P). It was established in the year 2006 under the affiliation of JNTUGV, Vizianagaram and approved by AICTE, New Delhi. The college is UGC Recognition under 2(f) & 12(B), ISO 9001:2015 Certified) SSCE is situated in a spacious 11 acres campus adjacent to NH-16 at Chilkapalem village. The college is easily accessible to all the districts nearby Srikakulam. SSCE offers B.Tech programmes in E.E.E, E.C.E, C.S.E, Mechanical and Civil Engineering, besides PG programmes M.C.A, M.B.A, M.Tech and Diploma programmes like E.E.E, Mechanical, and Civil Engineering as second shift. SSCE is completely Wi-Fi enabled and equipped with well established laboratories. The college has focused towards student centric learning atmosphere. The faculty is well qualified, experienced equipped with state of art technologies and dedicated to produce marketable products.

## ABOUT THE DEPARTMENT

The Department of Humanities and Basic Sciences, Sri Sivani College of Engineering was established in the year 2006. The department has always been on a progressive path, thanks to the experienced and dedicated faculty members who have a strong commitment towards providing quality engineering education.



### CHIEF PATRON

Sri. V.M.M. Sainadh Reddy, President

### PATRONS

Sri. J. Suryachandra Rao, Vice President

Sri. K. Durga Srinivas, Secretary

Sri. D. Venkata Rao, Treasurer

Sri. P. Durga Prasad Raju, Joint Secretary

Dr. S. Srinivasa Rao, Correspondent

### CHAIRMAN

Dr. Y. Srinivasa Rao

Principal, SSCE

### CONVENER

Mr. K. Madhukumar

Associate Professor

Dept. of H&BS

### Program Co-ordinator

Mr. K. Madhukumar

Associate Professor

Dept. of H&BS

Sri Sivani College of Engineering

akhil.kallakuri@gmail.com

9989026002

### RESOURCE PERSON

Dr. T. Kondala Rao

Professor, Dept. of H&BS

Sri Sivani College of Engineering

kondalaraotata@gmail.com

9440069430



## A TWO-WEEK ADD-ON PROGRAM ON "FUELS"

*(15th - 28th Dec 2022)*

Organized by  
Department of Humanities & Basic  
Sciences



**SRI SIVANI  
COLLEGE OF  
ENGINEERING**





## PROGRAM SCHEDULE:

1. Classifications of fuels.
2. Characteristics of good fuel.
3. Unit of heat.
4. Calorific Value.
5. Gross Calorific value.
6. Net Calorific value.
7. Determination of Calorific value.
8. Analysis of coal.
9. Ultimate analysis.
10. Proximate analysis.
11. Biogas

## OBJECTIVES:

- Describing the chemical reaction of combustion
- Listing the necessary components for combustion to occur
- Using word and simple symbol equations to explain combustion reactions.
- Explaining the difference between complete and incomplete combustion
- Giving examples of fuels and explaining their purposes
- Discovering both the pros and cons for using sources of energy
- Defining terms that relate to fossil fuels

## REGISTRATION FORM

A TWO-WEEK ADD-ON PROGRAM  
ON  
"FUELS"

(15th - 28th Dec 2022)

Participant's name :

Gender: Male/Female :

Educational Qualification :

Department :

Organization:

Address for Communication :

Mobile Number :

Email ID :

Date:

Signature of the Participant

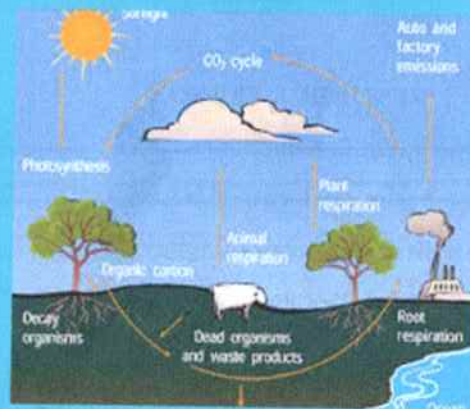
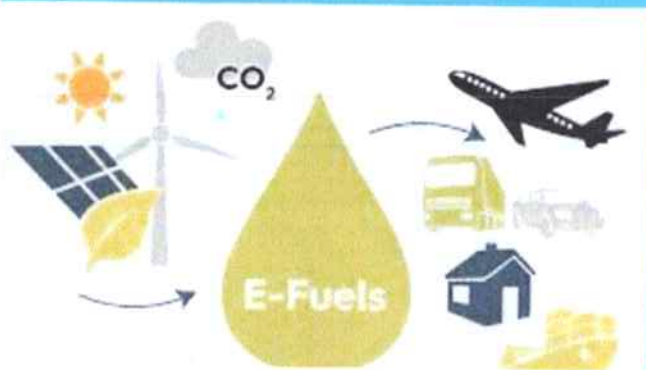
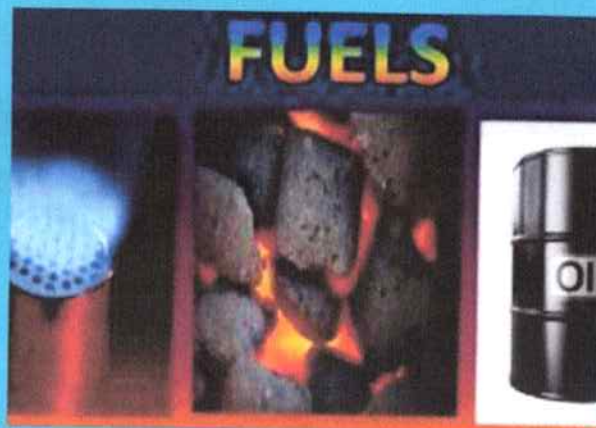





# SRI SIVANI COLLEGE OF ENGINEERING

(Under the Management of Sri Sivani Educational Society, Srikakulam)  
(Approved by AICTE, New Delhi and Affiliated to JNTUV, Vizianagaram-CC-W6,  
UGC Recognition under 2(f) & 12(B), ISO 9001:2015 Certified)  
NH-16, Chilakapalem Jn., Srikakulam Dist -532410

## DEPARTMENT OF HUMANITIES & BASIC SCIENCES

Academic Year: 2022-23

Date: 12-12-2022

Name of the program: A Two Week Add-On Program on "Fuels".

### List Of Enrolled Students

S.No	Roll No	Name Of The Student	Year/Sem	Signature
1	22W61A0101	AANEPU PRAVEEN	I/I	A. Praveen
2	22W61A0103	BALI SURESH	I/I	B. Suresh
3	22W61A0104	BEVARA NAVEEN KUMAR	I/I	B. Naveen Kumar
4	22W61A0105	BURAGANI MANIKANTA	I/I	B. Manikanta
5	22W61A0107	DATTI VAMSIKRISHNA	I/I	D. Vamsi Krishna
6	22W61A0108	GORLE SRIDEVI	I/I	G. Sridevi
7	22W61A0109	GUNTUBONU	I/I	G. Sridevi
8	22W61A0110	KONCHADA ANIL	I/I	K. Anil
9	22W61A0111	KONNA MADHAVA RAO	I/I	K. Madhava Rao
10	22W61A0113	MAKKA SAI TEJA	I/I	M. Sai Teja
11	22W61A0115	MEESALA MANEENDRA	I/I	M. Maneendra
12	22W61A0116	MULLU NAGAMANI	I/I	M. Nagamani
13	22W61A0117	RAGUTU YARRAM NAIDU	I/I	R. Yarram Naidu
14	22W61A0118	SUGGU TARUN	I/I	S. Tarun
15	22W61A0119	ADANGI MAHESH	I/I	A. Mahesh
16	22W61A0120	CHEPENA TEJA	I/I	C. Teja
17	22W61A0121	MADILA JAYA RAM	I/I	M. Jayaram
18	22W61A0122	MARPU DIVYA	I/I	M. Divya
19	22W61A0303	GAJJI NAGESWARARAO	I/I	G. Nageswararao
20	22W61A0304	PANGA RAMJEE	I/I	P. Ramjee
21	22W61A0305	ALLU SURYA	I/I	A. Surya
22	22W61A0306	CHODIPILLI RAJESH	I/I	CH. Rajesh
23	22W61A0501	ANKAM KAVYA	I/I	K. Raghavendra
24	22W61A0502	ARANGI HARITA	I/I	A. Haritha
25	22W61A0503	BAGANA BALAJI	I/I	B. Balaji
26	22W61A0504	BAIRI PADMA	I/I	B. Padma
27	22W61A0505	BARLA SATHWIK	I/I	B. Sathwik
28	22W61A0506	BASAVA BHAVANI	I/I	B. Bhavani
29	22W61A0507	BATCHALA SANJANA	I/I	B. Sanjana
30	22W61A0508	BATCHU VENKATA	I/I	B. Venkata
31	22W61A0509	BATTINI MOUNIKA	I/I	B. Mounika
32	22W61A0510	BAVIRI AKHILA	I/I	B. Akhila
33	22W61A0511	BEHARA SANTHOSHI	I/I	B. Santhoshi
34	22W61A0512	BENDALAM RAGHAVA	I/I	B. Raghava
35	22W61A0513	BHASURU PRIYANKA	I/I	B. Priyanka
36	22W61A0515	BISOY KARTIK	I/I	B. Kartik
37	22W61A0516	BODDURU SAI TEJESWARA	I/I	B. Sai Tejeswar
38	22W61A0517	BONGI KALI BABU	I/I	B. Kalibabu



S.No	Roll No	Name Of The Student	Year/Sem	Signature
39	22W61A0518	BORA JAIRAM	I/I	B. Jai Ram
40	22W61A0519	BUDDA VENKATARAMANA	I/I	Ch. Senth
41	22W61A0521	CHANAKUPPA SARATH	I/I	ch. sarath
42	22W61A0522	CHINTAM VINAY KUMAR	I/I	Ch. Vinay Kumar
43	22W61A0524	DUPANA SARATHBABU	I/I	O. SARATHBABU
44	22W61A0525	DUPPALA KULA SEKHAR	I/I	D. Kula Sekhar
45	22W61A0526	ELUSURI SHAKTI	I/I	E. shakti
46	22W61A0527	GONDALA PRASANTH	I/I	G. Prasanth
47	22W61A0528	GORLE CHAITANYA	I/I	G. Chaitanya
48	22W61A0529	GORUSETTI SRAVANI	I/I	G. Sravani
49	22W61A0530	GUDLA JAGANNADHA RAO	I/I	G. Sravani
50	22W61A0531	IPPILI BHANU PRAKASH	I/I	I. Bhano Prakash
51	22W61A0533	A JAGADEESWARA RAO	I/I	A. Jagadeeswararao
52	22W61A0534	KADIMISSETTY KUSUMA	I/I	K. Kusuma
53	22W61A0535	KANAPAKALA MAMATHA	I/I	K. mamatha
54	22W61A0536	KARRA ADARSH	I/I	K. Adarsh
55	22W61A0537	KARRI MANIKRISHNA	I/I	K. Mani Prakash
56	22W61A0538	KARRI SRAVAN KUMAR	I/I	K. Sravan Kumar
57	22W61A0539	KOLA SRUTHI	I/I	K. Sruthi
58	22W61A0540	KOPPALA NIHARIKA	I/I	K. Niharika
59	22W61A0541	KORADA MANOJU KUMAR	I/I	K. manojkumar
60	22W61A0542	KORNU HEMANI	I/I	K. hemani
61	22W61A0543	LABBA VENKATARAMANA	I/I	L. Venkataramana
62	22W61A0544	LAKSHMI POOJITHA	I/I	L. Poojitha
63	22W61A0545	LODDU KALYANI	I/I	L. Kalyani
64	22W61A0547	MAILAPALLI	I/I	M. Ramesh
65	22W61A0548	MAMIDI TANUJA	I/I	M. Tanuja
66	22W61A0549	MANDALA BHAGYASRI	I/I	M. Bhagathi
67	22W61A0550	MASADA DURGA PRASAD	I/I	M. Durga Prasad
68	22W61A0551	MASADA SAI	I/I	M. Sai
69	22W61A0552	MEESALA HEMANTH	I/I	M. hemanth
70	22W61A0553	NEYYILA VARUN	I/I	N. Varun
71	22W61A0554	PAILA KALYAN	I/I	P. Kalyan
72	22W61A0555	PARASELLI DIVYA	I/I	P. Divya
73	22W61A0556	PIRIYA MANEESH	I/I	P. maneesh
74	22W61A0557	POGIRI JAGADEESWARA	I/I	P. Jagadeeswar
75	22W61A0559	PONNADA BHAVANI	I/I	P. Bhavani
76	22W61A0560	PONNADA	I/I	P. Akash
77	22W61A0561	PUDI ROHITH	I/I	P. Rohith
78	22W61A0562	PULAPA VENKATARAO	I/I	P. venkatarao
79	22W61A0563	PUTTA UPENDRA	I/I	P. Upendra
80	22W61A0564	PYDI SOUJANYA	I/I	P. Soujanya
81	22W61A0565	RAJANA BALAKRISHNA	I/I	R. Balakrishna
82	22W61A0566	REDDI RAMBABU	I/I	R. Rambabu
83	22W61A0567	ROUTHU RAJU	I/I	R. Raju
84	22W61A0568	SAHUKARI VENKATESH	I/I	S. Venkatesh
85	22W61A0569	SAI SRAVANTHI KONDAVITI	I/I	K. Sai Sravanthi
86	22W61A0570	SAKALABATTULA RESHMA	I/I	S. Reshma
87	22W61A0571	SANAPALA PADMAVATHI	I/I	S. padmavathi



S.No	Roll No	Name Of The Student	Year/Sem	Signature
88	22W61A0572	SANKU SIRI	I/I	S. Siri
89	22W61A0573	SAVARA PRAMEELA	I/I	S. Prameela
90	22W61A0574	SEEPANA DEVIKA	I/I	S. Devika
91	22W61A0575	SETIGAM ADILAKSHMI	I/I	S. Adilakshmi
92	22W61A0576	SINGUPURAPU DEVI	I/I	S. Devi
93	22W61A0577	SINGUPURAPU VANI	I/I	S. Vani
94	22W61A0578	SISTU NIROSHA	I/I	S. Niroska
95	22W61A0579	SIVAKALA PRAVALLIKA	I/I	S. Pravalika
96	22W61A0580	SIVALANKI HARINADH	I/I	S. pravalika
97	22W61A0581	SURADA VISWESWARARAO	I/I	S. Visweswararao
98	22W61A0582	SURAPU TEJASWINI	I/I	S. Tejaswini
99	22W61A0583	SUVVARI	I/I	Suvvari
100	22W61A0584	TAMMINENI MADHAVI	I/I	T. madhavi
101	22W61A0585	THALABATHULA	I/I	Thalabathula
102	22W61A0586	TIPPANA NIRANJAN	I/I	T. Niranjana
103	22W61A0588	VANDANA GIREESHA	I/I	V. Gireesha
104	22W61A0590	VAPPANGI HIMAMANI SAI	I/I	V. Himamani Sai
105	22W61A0591	VARANASI MADHURI	I/I	V. Madhuri
106	22W61A0592	YERRA KARTHEEK	I/I	Y. KARTHEEK
107	22W61A0593	CHELLURU VIKASH	I/I	C. Vikash
108	22W61A0594	BHOGAPURAP U VENKATA	I/I	B. Venkata
109	22W61A0595	BURLA GANESH	I/I	B. Ganesh
110	22W61A0596	POIKAPLACKA L NITHIN	I/I	P. Nithin

  
Program Co-ordinator

  
Head of the Department





# SRI SIVANI COLLEGE OF ENGINEERING

(Under the Management of Sri Sivani Educational Society, Srikakulam)  
(Approved by AICTE, New Delhi and Affiliated to JNTUGV, Vizianagaram-CC-W6,  
UGC Recognition under 2(f) & 12(B), ISO 9001:2015 Certified)  
NH-16, Chilakapalem Jn., Srikakulam Dist -532410

## DEPARTMENT OF HUMANITIES & BASIC SCIENCES

Academic Year: 2022-23

Program Name: A Two Week Add-On Program on "Fuels "

### Day Wise Attendance Sheet

S.No	Roll No	Name Of The Student	01 15/12	02 16/12	03 17/12	04 19/12	05 20/12	06 21/12	07 22/12	08 23/12	09 24/12	10 26/12	11 27/12	12 28/12
1	22W61A0101	AANEPU PRAVEEN	P	P	P	P	A	P	P	P	P	P	P	A
2	22W61A0103	BALI SURESH	P	P	P	P	P	P	P	P	P	P	P	P
3	22W61A0104	BEVARA NAVEEN KUMAR	P	P	P	P	P	P	P	P	P	P	P	P
4	22W61A0105	BURAGANI MANIKANTA	P	P	P	P	P	P	P	A	P	P	A	P
5	22W61A0107	DATTI VAMSIKRISHNA	P	P	P	P	P	P	P	P	P	P	P	P
6	22W61A0108	GORLE SRIDEVI	P	P	P	P	P	A	P	P	P	P	P	P
7	22W61A0109	GUNTUBONU	A	P	P	P	P	P	P	P	P	P	P	P
8	22W61A0110	KONCHADA ANIL	P	P	P	A	P	P	P	P	P	A	P	P
9	22W61A0111	KONNA MADHAVA RAO	P	P	P	P	P	P	P	P	P	P	P	P
10	22W61A0113	MAKKA SAI TEJA	P	P	P	P	P	P	A	P	P	P	P	P
11	22W61A0115	MEESALA MANEENDRA	P	P	P	P	P	P	P	P	P	P	P	P
12	22W61A0116	MULLU NAGAMANI	P	P	P	P	P	P	P	P	A	P	P	P
13	22W61A0117	RAGUTU YARRAM NAIDU	P	P	P	P	P	P	P	P	P	P	P	A
14	22W61A0118	SUGGU TARUN	P	P	P	P	P	P	P	P	P	P	P	P
15	22W61A0119	ADANGI MAHESH	A	P	P	P	P	P	P	A	P	P	A	P
16	22W61A0120	CHEPENA TEJA	P	P	P	P	P	P	P	P	P	P	P	P
17	22W61A0121	MADILA JAYA RAM	P	P	P	P	P	P	P	P	P	P	P	P
18	22W61A0122	MARPU DIVYA	P	P	P	A	P	P	P	P	P	P	P	A
19	22W61A0303	GAJJI NAGESWARARAO	P	P	P	P	P	P	A	P	P	P	P	P
20	22W61A0304	PANGA RAMJEE	P	P	A	P	P	P	P	P	P	P	P	P
21	22W61A0305	ALLU SURYA	P	P	P	P	P	P	P	A	P	P	P	P
22	22W61A0306	CHODIPILLI RAJESH	A	P	P	P	A	P	P	P	P	P	P	P
23	22W61A0501	ANKAM KAVYA	P	P	P	P	P	P	P	P	A	P	P	A
24	22W61A0502	ARANGI HARITA	P	P	P	P	P	P	P	P	P	P	A	P
25	22W61A0503	BAGANA BALAJI	P	P	P	P	P	P	P	P	P	P	P	P
26	22W61A0504	BAIRI PADMA	P	A	P	P	P	P	P	P	P	P	P	P
27	22W61A0505	BARLA SATHWIK	P	P	P	P	P	P	P	P	P	P	P	P
28	22W61A0506	BASAVA BHAVANI	P	P	A	P	P	P	P	P	A	P	P	P
29	22W61A0507	BATCHALA SANJANA	P	P	P	P	P	P	P	P	P	P	A	P
30	22W61A0508	BATCHU VENKATA	P	P	P	P	P	P	P	P	P	P	P	P
31	22W61A0509	BATTINI MOUNIKA	P	P	A	P	P	P	P	A	P	P	P	P
32	22W61A0510	BAVIRI AKHILA	P	P	A	P	P	P	P	P	P	P	P	P
33	22W61A0511	BEHARA SANTHOSHI	P	P	P	A	P	P	P	P	P	P	P	P
34	22W61A0512	BENDALAM RAGHAVA	P	A	P	P	P	P	A	P	P	P	P	P



S.No	Roll No	Name Of The Student	01	02	03	04	05	06	07	08	09	10	11	12
			15/12	16/12	17/12	19/12	20/12	21/12	22/12	23/12	24/12	26/12	27/12	28/12
35	22W61A0513	BHASURU PRIYANKA	P	P	P	P	P	P	P	P	P	P	P	P
36	22W61A0515	BISOY KARTIK	P	A	P	P	P	P	P	P	P	P	P	P
37	22W61A0516	BODDURU SAI TEJESWARA	P	P	P	P	P	P	P	P	P	P	P	P
38	22W61A0517	BONGI KALI BABU	P	P	P	P	P	P	P	P	P	A	P	P
39	22W61A0518	BORA JAIRAM	P	P	P	P	P	P	P	P	P	P	P	P
40	22W61A0519	BUDDA VENKATARAMANA	P	P	P	P	A	P	P	P	P	P	P	A
41	22W61A0521	CHANAKUPPA SARATH	P	P	P	P	P	P	P	P	A	P	P	P
42	22W61A0522	CHINTAM VINAY KUMAR	P	P	P	P	P	A	P	P	P	P	P	P
43	22W61A0524	DUPANA SARATHBABU	P	P	A	P	P	P	P	P	P	P	P	P
44	22W61A0525	DUPPALA KULA SEKHAR	P	P	P	P	P	P	P	P	P	P	P	P
45	22W61A0526	ELUSURI SHAKTI	P	P	P	P	A	P	P	P	P	P	P	P
46	22W61A0527	GONDALA PRASANTH	P	P	P	P	P	P	P	P	P	P	P	P
47	22W61A0528	GORLE CHAITANYA	A	P	P	P	P	P	P	P	P	P	P	P
48	22W61A0529	GORUSETTI SRAVANI	P	P	P	P	P	P	A	P	P	P	P	P
49	22W61A0530	GUDLA JAGANNADHA RAO	P	P	P	A	P	P	P	P	P	P	A	P
50	22W61A0531	IPPILI BHANU PRAKASH	P	P	P	P	P	P	P	P	P	P	P	P
51	22W61A0533	A JAGADEESWARA RAO	P	A	P	P	P	P	P	P	P	A	P	P
52	22W61A0534	KADIMISSETTY KUSUMA	P	P	P	P	P	P	P	P	P	P	P	P
53	22W61A0535	KANAPAKALA MAMATHA	P	P	P	P	P	P	P	P	P	P	P	A
54	22W61A0536	KARRA ADARSH	P	P	P	P	A	P	P	P	A	P	P	P
55	22W61A0537	KARRI MANIKRISHNA	P	P	P	P	P	P	P	P	P	P	P	P
56	22W61A0538	KARRI SRAVAN KUMAR	P	P	P	P	P	P	P	P	P	P	P	P
57	22W61A0539	KOLA SRUTHI	P	P	P	P	P	P	A	P	P	P	P	P
58	22W61A0540	KOPPALA NIHARIKA	P	P	P	P	P	P	P	P	P	P	P	P
59	22W61A0541	KORADA MANOJU KUMAR	A	P	P	P	P	P	P	P	P	P	P	A
60	22W61A0542	KORNU HEMANI	P	P	P	P	P	P	P	P	P	P	P	P
61	22W61A0543	LABBA VENKATARAMANA	P	P	P	P	P	P	P	A	P	P	P	P
62	22W61A0544	LAKSHMI POOJITHA	P	P	P	P	P	P	P	P	P	P	A	P
63	22W61A0545	LODDU KALYANI	P	P	A	P	P	P	P	P	P	P	P	P
64	22W61A0547	MAILAPALLI	P	P	P	P	P	P	P	P	P	A	P	P
65	22W61A0548	MAMIDI TANUJA	P	P	P	A	P	P	P	P	P	P	P	P
66	22W61A0549	MANDALA BHAGYASRI	P	P	P	P	P	P	P	P	P	P	P	P
67	22W61A0550	MASADA DURGA PRASAD	P	P	P	P	A	P	P	P	P	P	P	P
68	22W61A0551	MASADA SAI	P	P	P	P	P	P	P	P	A	P	A	P
69	22W61A0552	MEESALA HEMANTH	P	A	P	P	P	P	P	P	P	P	P	P
70	22W61A0553	NEYYILA VARUN	P	P	P	P	P	P	P	P	P	P	P	P
71	22W61A0554	PAILA KALYAN	P	P	P	P	P	A	P	P	P	P	P	P
72	22W61A0555	PARASELLI DIVYA	A	P	P	P	P	P	P	P	P	P	P	P
73	22W61A0556	PIRIYA MANEESH	P	P	P	P	P	P	P	P	P	P	P	A
74	22W61A0557	POGIRI JAGADEESWARA	P	P	P	P	P	P	P	P	P	P	P	P
75	22W61A0559	PONNADA BHAVANI	P	P	P	A	P	P	P	A	P	P	P	P
76	22W61A0560	PONNADA	P	P	P	P	P	P	P	P	P	P	P	P
77	22W61A0561	PUDI ROHITH	P	P	P	P	P	P	P	P	P	P	P	P
78	22W61A0562	PULAPA VENKATARAO	P	A	P	P	P	P	P	P	P	P	P	P
79	22W61A0563	PUTTA UPENDRA	P	P	P	P	P	P	P	P	P	P	P	P
80	22W61A0564	PYDI SOUJANYA	P	P	P	P	P	P	P	P	P	A	P	P
81	22W61A0565	RAJANA BALAKRISHNA	P	P	P	P	P	P	P	P	P	P	P	P
82	22W61A0566	REDDI RAMBABU	P	P	A	P	P	P	P	P	P	P	P	P



S.No	Roll No	Name Of The Student	01 15/12	02 16/12	03 17/12	04 19/12	05 20/12	06 21/12	07 22/12	08 23/12	09 24/12	10 26/12	11 27/12	12 28/12
83	22W61A0567	ROUTHU RAJU	P	P	P	P	P	P	P	P	A	P	P	P
84	22W61A0568	SAHUKARI VENKATESH	P	P	P	P	A	P	P	P	P	P	P	P
85	22W61A0569	SAI SRAVANTHI KONDAVITI	P	P	P	P	P	P	P	A	P	P	P	P
86	22W61A0570	SAKALABATTULA RESHMA	P	P	P	P	P	P	P	P	P	P	P	P
87	22W61A0571	SANAPALA PADMAVATHI	P	P	P	A	P	P	P	P	P	A	P	P
88	22W61A0572	SANKU SIRI	P	P	P	P	P	P	A	P	P	P	P	P
89	22W61A0573	SAVARA PRAMEELA	P	P	A	P	P	P	P	P	P	P	P	P
90	22W61A0574	SEEPANA DEVIKA	P	P	P	P	P	P	P	P	P	P	A	P
91	22W61A0575	SETIGAM ADILAKSHMI	P	A	P	P	P	P	P	P	P	P	P	P
92	22W61A0576	SINGUPURAPU DEVI	P	P	P	P	A	P	P	P	P	P	P	P
93	22W61A0577	SINGUPURAPU VANI	P	P	P	P	P	P	P	P	P	P	P	P
94	22W61A0578	SISTU NIROSHA	P	P	P	A	P	P	P	P	A	P	P	P
95	22W61A0579	SIVAKALA PRAVALLIKA	P	P	P	P	P	P	P	A	P	P	P	P
96	22W61A0580	SIVALANKI HARINADH	P	P	P	P	P	P	P	P	P	P	P	P
97	22W61A0581	SURADA VISWESWARARAO	P	P	P	P	A	P	P	P	P	P	P	P
98	22W61A0582	SURAPU TEJASWINI	P	P	P	P	P	P	P	P	P	P	P	P
99	22W61A0583	SUVVARI	P	P	P	P	P	P	P	P	P	P	P	P
100	22W61A0584	TAMMINENI MADHAVI	P	P	P	A	P	P	P	P	P	P	P	P
101	22W61A0585	THALABATHULA	P	P	P	P	P	P	P	P	P	P	A	A
102	22W61A0586	TIPPANA NIRANJAN	A	P	P	P	P	P	P	P	P	P	P	P
103	22W61A0588	VANDANA GIREESHA	P	P	P	P	P	P	P	P	P	P	P	P
104	22W61A0590	VAPPANGI HIMAMANI SAI	P	P	P	P	P	P	P	P	P	A	P	P
105	22W61A0591	VARANASI MADHURI	P	P	A	P	P	P	A	P	P	P	P	P
106	22W61A0592	YERRA KARTHEEK	P	P	P	P	P	P	P	P	P	P	P	P
107	22W61A0593	CHELLURU VIKASH	P	P	P	P	A	P	P	P	P	P	P	P
108	22W61A0594	BHOGAPURAP U VENKATA	P	P	P	P	P	P	P	P	P	P	P	P
109	22W61A0595	BURLA GANESH	P	P	P	P	P	P	P	A	P	P	P	P
110	22W61A0596	POIKAPLACKA L NITHIN	P	P	P	P	P	P	P	P	A	P	P	P
Signature :			<i>[Signature]</i>	<i>[Signature]</i>	<i>[Signature]</i>	<i>[Signature]</i>	<i>[Signature]</i>	<i>[Signature]</i>	<i>[Signature]</i>	<i>[Signature]</i>	<i>[Signature]</i>	<i>[Signature]</i>	<i>[Signature]</i>	<i>[Signature]</i>

*[Signature]*  
Program Co-ordinator



# SRI SIVANI COLLEGE OF ENGINEERING

(Under the Management of Sri Sivani Educational Society, Srikakulam)  
(Approved by AICTE, New Delhi and Affiliated to JNTUV, Vizianagaram-CC-W6,  
UGC Recognition under 2(f) & 12(B), ISO 9001:2015 Certified)  
NH-16, Chilakapalem Jn., Srikakulam Dist -532410

## DEPARTMENT OF HUMANITIES & BASIC SCIENCES

Academic year: 2022-23

Date: 02-01-2023

### PROGRAM REPORT

**Name of the program** : A Two Week Add-On Program on "Fuels".

**Date** : 15-12-2022 to 28-12-2022

**Details of Resource Persons** : Dr.T Kondala Rao,  
Professor,  
Dept. of H&Bs,  
Sri Sivani College of Engineering  
[kondalaraotata@gmail.com](mailto:kondalaraotata@gmail.com)  
9440069430

**Details of Program coordinator** : Mr. K. Madhukumar, M.A,  
Associate Professor,  
Dept. of H&Bs,  
Sri Sivani College of Engineering  
[Akhil.kallakuri@gmail.com](mailto:Akhil.kallakuri@gmail.com)  
9989026002

#### **Objectives of the program:**

- Describing the chemical reaction of combustion
- Listing the necessary components for combustion to occur
- Using word and simple symbol equations to explain combustion reactions
- Explaining the difference between complete and incomplete combustion
- Giving examples of fuels and explaining their purposes
- Discovering both the pros and cons for using sources of energy
- Defining terms that relate to fossil fuels

#### **Topics covered:**

1. Classifications of fuels.
2. Characteristics of good fuel.
3. Unit of heat.



4. Calorific Value.
5. Gross Calorific value.
6. Net Calorific value.
7. Determination of Calorific value.
8. Analysis of coal.
9. Ultimate analysis.
10. Proximate analysis.
11. Biogas.

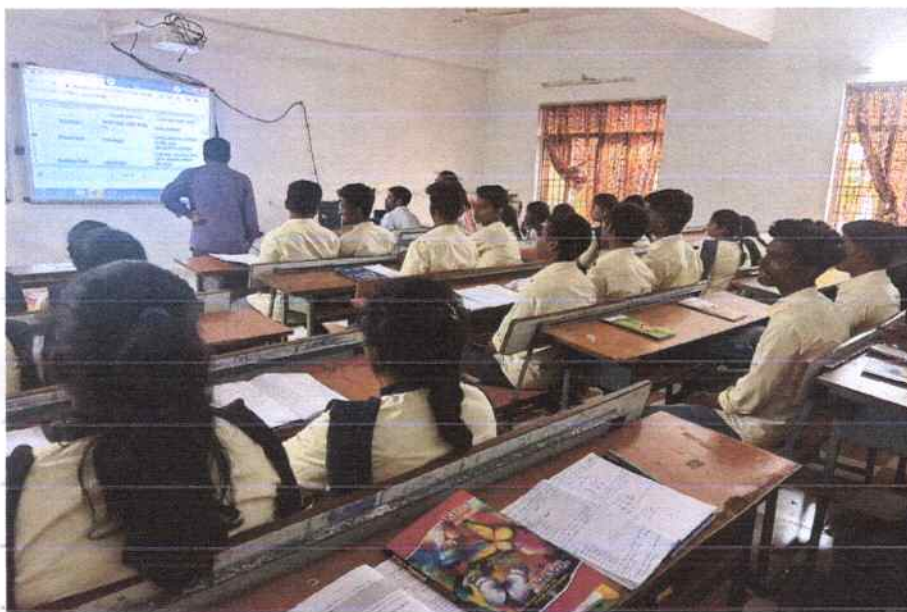

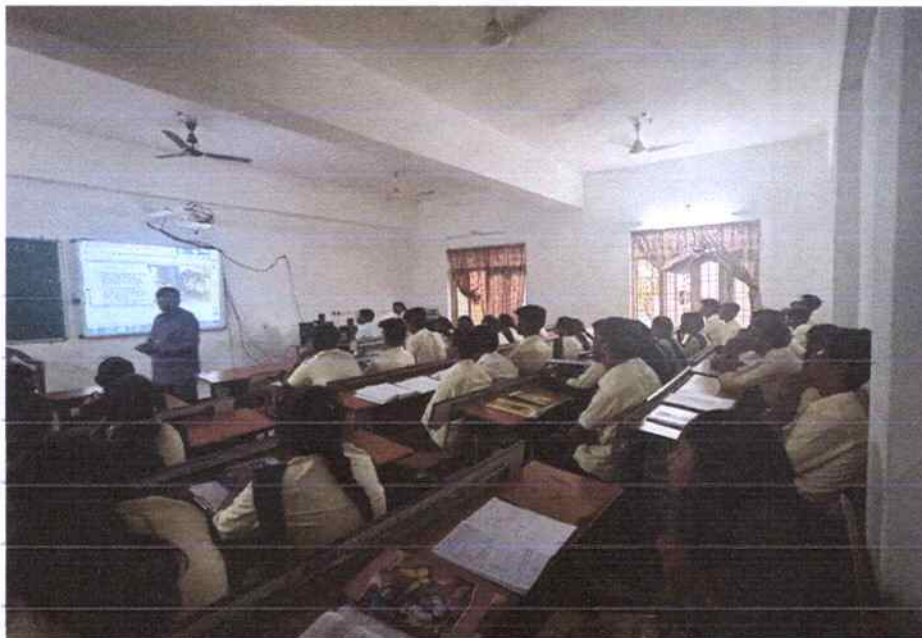

**Outcomes of the program:**

On completion of the course, student should be able to:

1. Understand the environmental impact of burning fuels and the use of alternative fuels as energy sources.

**Number of participants : 110**

  
**Program Co-ordinator**





# SRI SIVANI COLLEGE OF ENGINEERING

(Under the Management of Sri Sivani Educational Society, Srikakulam)  
(Approved by AICTE, New Delhi and Affiliated to JNTUV, Vizianagaram-CC-W6,  
UGC Recognition under 2(f) & 12(B), ISO 9001:2015 Certified)  
NH-16, Chilakapalem, Srikakulam, A.P.-532410

## Certificate of Participation

This is certifying that Mr./Ms Gorle. sridevi bearing

Roll No. 22W61A0108 Of I Year I semester has completed A Two week Add-On program on "Fuels"  
during the Period 15-12-2022 to 28-12-2022 organized by Department of Humanities & Basic sciences.

  
Co-ordinator

  
HOD

  
Principal



# SRI SIVANI COLLEGE OF ENGINEERING

(Under the Management of Sri Sivani Educational Society, Srikakulam)  
(Approved by AICTE, New Delhi and Affiliated to JNTUV, Vizianagaram-CC-W6,  
UGC Recognition under 2(f) & 12(B), ISO 9001:2015 Certified)  
NH-16, Chilakapalem, Srikakulam, A.P.-532410

## Certificate of Participation

This is certifying that Mr./Ms Bavari Akhila bearing

Roll No. 22W61A0510 Of I Year I semester has completed A Two week Add-On program on “**Fuels**”  
during the Period 15-12-2022 to 28-12-2022 organized by Department of Humanities & Basic sciences.

  
Co-ordinator

  
HOD

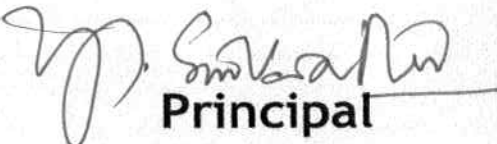
  
Principal





# SRI SIVANI COLLEGE OF ENGINEERING

(Under the Management of Sri Sivani Educational Society, Srikakulam)  
(Approved by AICTE, New Delhi and Affiliated to JNTUV, Vizianagaram-CC-W6,  
UGC Recognition under 2(f) & 12(B), ISO 9001:2015 Certified)  
NH-16, Chilakapalem, Srikakulam, A.P.-532410

## Certificate of Participation

This is certifying that Mr./Ms Georle. chaitanya bearing

Roll No. 22WG1A0528 Of I Year I semester has completed A Two week Add-On program on "Fuels"  
during the Period 15-12-2022 to 28-12-2022 organized by Department of Humanities & Basic sciences.

  
Co-ordinator

  
HOD

  
Principal



# SRI SIVANI COLLEGE OF ENGINEERING

(Under the Management of Sri Sivani Educational Society, Srikakulam)  
(Approved by AICTE, New Delhi and Affiliated to JNTUV, Vizianagaram-CC-W6,  
UGC Recognition under 2(f) & 12(B), ISO 9001:2015 Certified)  
NH-16, Chilakapalem, Srikakulam, A.P.-532410

## Certificate of Participation

This is certifying that Mr./Ms Routhu. Raju bearing

Roll No. 22W6IA0567 Of I Year I semester has completed A Two week Add-On program on "Fuels"  
during the Period 15-12-2022 to 28-12-2022 organized by Department of Humanities & Basic sciences.

  
Co-ordinator

  
HOD

  
Principal





# SRI SIVANI COLLEGE OF ENGINEERING

(Under the Management of Sri Sivani Educational Society, Srikakulam)  
(Approved by AICTE, New Delhi and Affiliated to JNTUGV, Vizianagaram-CC-W6,  
UGC Recognition under 2(f) & 12(B), ISO 9001:2015 Certified)  
NH-16, Chilakapalem Jn., Srikakulam Dist. Andhra Pradesh -532410

Date: 14-12-2022

## CIRCULAR

Here by informed to all the students of MBA, that the Department of Management Studies is planning to organize **A Two-week Add-On Program on "Work-Life Balance"** from **26-12-2022 to 07-01-2023**. This program is aimed at enhancing your skills and knowledge in the field of Work-Life Balance is about finding a way to manage the demands of your work or study with your personal life and the things top you up. In this regard, I suggest all the 1<sup>st</sup> and 2<sup>nd</sup> year MBA students to enroll this program on or before **20-12-2022**.







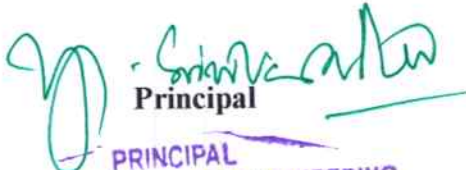



**Venue:** Seminar Hall, Block – 1, SSCE.

Co-ordinator: Ms.V. Ramya. Asst. Prof,

Department of Management Studies

  
Principal  
PRINCIPAL  
SRI SIVANI COLLEGE OF ENGINEERING  
Chilakapalem Jn., SRIKAKULAM

**Copy to**

Dept.	IQAC	Civil	EEE	Mech	ECE	CSE	H&BS	MBA	TPO	Office	Library
Signature											

CC To: The Management: for information.



# SRI SIVANI COLLEGE OF ENGINEERING

(Under the Management of Sri Sivani Educational Society, Srikakulam)  
(Approved by AICTE, New Delhi and Affiliated to JNTUGV, Vizianagaram-CC-W6,  
UGC Recognition under 2(f) & 12(B), ISO 9001:2015 Certified)  
NH-16, Chilakapalem Jn., Srikakulam Dist. Andhra Pradesh -532410

## Department of Management Studies

Academic Year: 2022-23

Date: 14-12-2022

Name of the program: A Two-week Add-On Program on "Work Life Balance"

### PROGRAM SCHEDULE

S.no	Date	Topics To Be Covered
1	26-12-2022	Introduction to Work-Life Balance
2	27-12-2022	The problem of work-family imbalance in society
3	28-12-2022	Flexible work schedule and work-life balance
4	29-12-2022	The importance of work-life balance
5	30-12-2022	Studying and working balance
6	31-12-2022	Impact of work life balance on employees life
7	02-01-2023	The relations between employer flexibility & employee work life balance
8	03-01-2023	Correlation of employment and appropriate work life balance
9	04-01-2023	Work-life balance policies for employees and employers
10	05-01-2023	Key factors determining work-life balance
11	06-01-2023	The work life balance is a key to being best
12	07-01-2023	Review and conclusion

  
Program Co-ordinator

  
Head of the Department



## About the Institution

Sri Sivani College of Engineering was established in the year 2006 by the highly motivated and philanthropic personalities well noted in the Srikakulam district for their commitment and concern for upliftment of education. The College recognizes the vital need to produce competent engineering professionals and techno managerial professionals for the development of country. It is spread over 11.10 acres of land, with picturesque landscape providing calm learning atmosphere. The campus is eco-friendly and an ideal location for studies. The institution is established as a co-educational institution and affiliated to JNTUGV, Vizianagaram.

The Management believes in the three principles for the success of true education based on discipline, dedication and commitment. Here the environment is free from all limitations and tensions. The institution aims at achieving excellence in engineering education, not only at basic level but also at advanced levels. Sri Sivani is the abode where the experienced faculty with their broader vision set their goals to fulfill the dreams of the students with better employability skills. Campus recruitments are often conducted by inviting renowned companies. Healthy atmosphere pervades within and outside the campus. Competitive spirit is encouraged among the students. Every year students are presented with meritorious awards and gold medals based on their performance.



## PATRONS

**Sri V.M.M. SAINADH REDDY,**  
President

**Sri J. SURYACHANDRA RAO,**  
Vice President

**Sri K. DURGA SRINIVAS,**  
Secretary

**Sri D. VENKATA RAO,**  
Treasurer

**Sri P. DURGA PRASAD RAJU,**  
Joint Secretary

**Sri S. SRINIVASA RAO,**  
Correspondent

## CHAIRMAN

**Dr. Y.Srinivasa Rao,**  
Principal, SSCE

## ORGANISING COMMITTEE

**Mr. K. Ravi Kumar**

**Head of the Department**

**Department of Management Studies**

**Program Co-ordinator**

**Ms.V. Ramya**

**Assistant professor**

**Mobile: 9063303929**

**Email: vungatiramya@gmail.com**

## Sri Sivani College of Engineering

(Under the Management of Sri Sivani Educational Society, Srikakulam) Approved by AICTE, New Delhi and Affiliated to JNTUGV, Vizianagaram-CC-W6, UGC Recognition under 2(f) & 12(B), ISO 9001:2015 Certified) NH-16, Chilakapalem Jn., Srikakulam Dist. Andhra Pradesh -532410



## A Two-week Add-On Program on "Work-Life Balance"

**26-12-2022 to 07-01-2023**

**Organized  
By**

**Department of Management Studies**





## **ABOUT THE DEPARTMENT**

The Department of management studies was established in the academic year 2008 with an annual intake of 60. The Department is offering full time two year post graduation course since inception of the Institution. The Department focuses on preparing the students for wide range of management careers equipping them with unique enriching experience of molding tomorrow's technocrats with high caliber and commitment.

## **MASTER OF BUSINESS ADMINISTRATION**

MBA. in finance, marketing, human resource management includes study of various aspects to meet the requirements of the various industries. The course contains study of the basic administration and its application, as well as the detailed study of the various aspects of its working. the course of in master of business administration trains an individual in the fields related to finance, marketing, human resource management and its industry.

## **RESOURCE PERSON**

Dr. Prasad Rao Bondada, M.B.A, PhD  
Associate Professor,  
Dept. of MBA,  
Sri Sivani College of Engineering  
prasadaraobondada@gmail.com,  
9912940557

## **PROGRAM CONTENT**

1. Introduction to Work-Life Balance
2. The problem of work-family imbalance in society
3. Flexible work schedule and work-life balance
4. The importance of work-life balance
5. Studying and working balance
6. Impact of work life balance on employees life
7. The relations between employer flexibility &
8. Employee work life balance
9. Correlation of employment and appropriate work life balance
10. Work-life balance policies for employees and employers
11. Key factors determining work-life balance
12. The work life balance is a key to being best
13. Review and conclusion



## **REGISTRATION FORM**

### **A Two-week Add-On Program on "Work - Life Balance"**

Participant's Name:

Gender: Male/Female

Educational Qualifications:

Department:

Organization:

Address for Communication:

Phone No:

Email:

Date:

Signature of the Participant:





# SRI SIVANI COLLEGE OF ENGINEERING

(Under the Management of Sri Sivani Educational Society, Srikakulam)  
(Approved by AICTE, New Delhi and Affiliated to JNTUGV, Vizianagaram-CC-W6,  
UGC Recognition under 2(f) & 12(B), ISO 9001:2015 Certified)  
NH-16, Chilakapalem Jn., Srikakulam Dist. Andhra Pradesh -532410

## Department of Management Studies

Academic Year: 2022-23

Date: 20-12-2022

Name of the program: A Two-Week Add-On Program on "Work-Life Balance"

### List of Enrolled Students

S.no	Roll no	Name of the Student	Year-Sem	Signature
1	21W61E0001	Allu Shirisha	II-I	A. Shirisha
2	21W61E0003	Bammidi Tulasidas	II-I	B. Tulasidas
3	21W61E0004	Banna Jayaram	II-I	B. Jayaram
4	21W61E0005	Baratam Sai Eswar	II-I	B. Sai Eswar
5	21W61E0006	Basetti Pushpa	II-I	B. Pushpa
6	21W61E0007	Behara Neelima	II-I	B. Neelima
7	21W61E0009	Boddepalli Harika	II-I	B. Harika
8	21W61E0010	Botsa Ganesh	II-I	B. Ganesh
9	21W61E0011	Buridi Yugandhar	II-I	B. YUGANDHAR
10	21W61E0012	Butcha Venkata Ramana Reddy	II-I	B. Venkata Ramana
11	21W61E0013	Dupplapuri Hari Babu	II-I	D. HARIBABU
12	21W61E0014	Dandupati Rajasekhara	II-I	D. Rajasekhara
13	21W61E0015	Dasari Anil	II-I	D. Anil
14	21W61E0016	Duppada Mounika	II-I	D. Mounika
15	21W61E0018	Goddu Dilleswara Rao	II-I	G. Dilleswara Rao
16	21W61E0019	Gudla Divakar	II-I	G. Divakar
17	21W61E0020	Guntrothu Amruth Kumar	II-I	G. Amruth Kumar
18	21W61E0021	Ijjada Durga Prasad	II-I	I. Durgaprasad
19	21W61E0022	Jaddu Prasadu	II-I	J. Prasadu
20	21W61E0023	Jamma Sudheer Kumar	II-I	J. Sudheer Kumar
21	21W61E0025	K.S.V.V.S.Narayana Murthy	II-I	K. Narayana Murthy
22	21W61E0026	Kadagala Damodara Rao	II-I	K. Damodara Rao



23	21W61E0028	Karri Rambabu	II-I	K. Rambabu
24	21W61E0030	Kutikuppala Devi Prasad	II-I	K. Devi Prasad
25	21W61E0031	Laveti Raminaidu	II-I	L. Raminaidu
26	21W61E0032	Locherla Naresh	II-I	L. Naresh
27	21W61E0035	Maruji Asha Jyothi	II-I	M. Asha Jyothi
28	21W61E0036	Mirtivada Hari Babu	II-I	M. Hari
29	21W61E0037	Monangi Shanmukha Rao	II-I	M. Shanmukha
30	21W61E0039	Nakka Mounika	II-I	N. Mounika
31	21W61E0041	Panangipalli Prasoon	II-I	P. Prasoon
33	21W61E0042	Pappu Sandhya Rani	II-I	P. Sandhya Rani
34	21W61E0043	Pediredla Madhuri Surya	II-I	P. Madhuri Surya
35	21W61E0044	Potnuru Bhagyaraj	II-I	P. Bhagyaraj
36	21W61E0046	Rally Sai Kiran	II-I	R. Sai Kiran
37	21W61E0047	Sabbi Suresh	II-I	S. Suresh
38	21W61E0048	Sankabattula Sireesha	II-I	S. Sireesha
39	21W61E0049	Savara Eswararao	II-I	S. Eswara Rao
40	21W61E0050	Savara Sandeswara Rao	II-I	S. Sandeswara Rao
41	21W61E0051	Sheik Chandini	II-I	sheik. chandini
42	21W61E0052	Sivala Bhagyam	II-I	S. Bhagyam
43	21W61E0055	Uriti Veera Venkata Sai	II-I	U. Veena Venkata Sai
44	21W61E0056	Voona Sireesha	II-I	U. Sireesha
45	21W61E0057	Vysyaraju Goutham	II-I	V. Goutham
46	22W61E0001	A Venkata Surya Manimala	I-I	A. Venkata.
47	22W61E0002	Alupana Nikhil Reddi	I-I	A. Nikhil Reddi
48	22W61E0003	Baratam Mohana Krishna	I-I	B. Mohana Krishna
49	22W61E0004	Baratam Roshini	I-I	B. Roshini
50	22W61E0005	Batta Buddeswararao	I-I	B. Buddeswararao
51	22W61E0006	Bendi Krishna Prasad	I-I	B. Krishna Prasad
52	22W61E0007	Bendi Shravani	I-I	B. Shravani
53	22W61E0008	Cheedi Lokesh	I-I	C. Lokesh.
54	22W61E0009	Daketi Krishnaveni	I-I	D. Krishnaveni
55	22W61E0010	Dakoju Sai Deepika	I-I	D. Sai Deepika.
56	22W61E0011	Dannana Naveen	I-I	D. Naveen



57	22W61E0012	Dasari Manikanta	I-I	D. Manikanta.
58	22W61E0013	Desetti Manoj Kumar	I-I	D. Manoj Kumar
59	22W61E0014	Devupalli Yernibabu	I-I	D. Yernibabu
60	22W61E0015	Dola Tarakarama Rao	I-I	D. Tarakarama Rao
61	22W61E0016	Gangu Tejeswara Rao	I-I	G. Tejeswara Rao
62	22W61E0017	Gedala Aravinda Reddy	I-I	G. Aravinda Reddy
63	22W61E0018	Gollangi Prasad	I-I	G. Prasad
64	22W61E0019	Gondu Lakshmana Rao	I-I	G. Lakshmana Rao
65	22W61E0020	Gondu Tilak	I-I	G. Tilak
66	22W61E0021	Gulipili Sateesh	I-I	G. Sateesh
67	22W61E0022	Gulivindala Sai	I-I	G. Sai
68	22W61E0023	Gunupuram Jagadeesh	I-I	G. Jagadeesh
69	22W61E0024	Gunupuru Sankara Rao	I-I	G. Sankara Rao
70	22W61E0025	Jada Suresh	I-I	J. Suresh.
71	22W61E0026	Jenjului Harish Kumar	I-I	J. Harish Kumar
72	22W61E0027	Kadupukutla Rambabu	I-I	K. Ram Babu
73	22W61E0028	Karri Shanmukarao	I-I	K. Shanmukarao
74	22W61E0029	Kondala Lakshmanarao	I-I	K. Lakshmanarao
75	22W61E0030	Kondi Prameela	I-I	K. Prameela
76	22W61E0031	Kranti Kumar Chowdary B	I-I	K. Kumar
77	22W61E0032	Kuna Sai Akshay	I-I	K. Sai Akshay
78	22W61E0034	Mamidi Manikanta	I-I	M. Manikanta
79	22W61E0035	Manda Jhansi	I-I	M. Jhansi
80	22W61E0036	Mudda Srinivasa Rao	I-I	M. Srinivasa Rao
81	22W61E0037	Munganti Haritha	I-I	M. Haritha
82	22W61E0038	Nalli Vasu	I-I	N. Vasu.
83	22W61E0040	Pillala Devarao	I-I	P. Devarao
84	22W61E0042	Ponnana Suguna	I-I	P. Suguna
85	22W61E0043	Putta Geetha	I-I	P. Geetha
86	22W61E0044	Pydi Sai Chandra	I-I	P. Saichandra
87	22W61E0045	Runkana Madhavi	I-I	R. Madhavi
88	22W61E0046	Runkana Umamaheswara Rao	I-I	R. Umamaheswara Rao
89	22W61E0047	Savara Adinarayana	I-I	S. Adinarayana

90	22W61E0048	Siridi Naveen	I-I	S. Naveen
91	22W61E0049	Siripurapu Ravi Teja	I-I	S. Ravi Teja
92	22W61E0050	Tirumalapeddinti Srikanth	I-I	T. Srikanth
93	22W61E0051	Uthla Tejaswi	I-I	U. Tejaswi
94	22W61E0053	Vana Kiran Kumar	I-I	V. Kiran Kumar
95	22W61E0054	Vavilapalli Rama Devi	I-I	V. Rama Devi
96	22W61E0055	Yalakala Hari Krishna	I-I	Y. Hari Krishna
97	22W61E0056	Yenda Yuva Kiran	I-I	Y. Yuva Kiran

  
Program Co-ordinator

  
Head of the Department





# SRI SIVANI COLLEGE OF ENGINEERING

(Under the Management of Sri Sivani Educational Society, Srikakulam)  
(Approved by AICTE, New Delhi and Affiliated to JNTUGV, Vizianagaram-CC-W6,  
UGC Recognition under 2(f) & 12(B), ISO 9001:2015 Certified)  
NH-16, Chilakapalem Jn., Srikakulam Dist. Andhra Pradesh -532410

## Department of Management Studies

Academic Year: 2022-23

Program Name: A Two-week Add-On Program on "Work-Life Balance"

### Day Wise Attendance Sheet

S.no	Roll no	Name of The Student	01	02	03	04	05	06	07	08	09	10	11	12
			26/12	27/12	28/12	29/12	30/12	31/12	02/1	03/01	04/01	05/01	06/01	07/01
1	21W61E0001	Allu Shirisha	P	P	P	P	P	A	P	P	P	P	P	P
2	21W61E0003	BammidiTulasidas	P	P	P	P	P	P	A	P	P	P	P	P
3	21W61E0004	BannaJayaram	P	A	P	P	P	P	P	P	P	P	P	P
4	21W61E0005	Baratam Sai Eswar	P	P	P	A	P	P	P	P	P	P	P	P
5	21W61E0006	BasettiPushpa	P	P	P	P	P	P	P	P	P	A	P	P
6	21W61E0007	BeharaNeelima	P	P	P	P	P	A	P	P	P	P	P	P
7	21W61E0009	BoddepalliHarika	A	P	P	P	P	P	P	P	P	P	P	P
8	21W61E0010	Botsa Ganesh	P	P	P	P	P	P	A	P	P	P	P	P
9	21W61E0011	BuridiYugandhar	P	P	A	P	P	P	P	P	P	P	P	P
10	21W61E0012	ButchaVenkataRamana Reddy	P	P	P	P	P	A	P	P	P	P	P	P
11	21W61E0013	Dupplapuri Hari Babu	P	A	P	P	P	P	P	P	P	P	P	P
12	21W61E0014	DandupatiRajasekhar	P	P	P	P	A	P	P	P	P	P	P	P
13	21W61E0015	Dasari Anil	P	P	P	A	P	P	P	P	P	P	P	P
14	21W61E0016	DuppadaMounika	P	P	P	P	P	P	P	P	P	P	A	P
15	21W61E0018	GodduDilleswara Rao	P	P	P	P	P	P	P	A	P	P	P	P
16	21W61E0019	GudlaDivakar	P	P	P	P	A	P	P	P	P	P	P	P
17	21W61E0020	GuntrothuAmruth Kumar	P	P	P	P	P	P	P	P	A	P	P	P
18	21W61E0021	IjjadaDurga Prasad	P	P	P	P	P	P	P	A	P	P	P	P

19	21W61E0022	JadduPrasadu	P	P	P	P	P	A	P	P	P	P	P	P
20	21W61E0023	JammaSudheer Kumar	P	P	P	P	P	P	A	P	P	P	P	P
21	21W61E0025	K.S.V.V.S.Narayana Murthy	P	P	P	A	P	P	P	P	P	P	P	P
22	21W61E0026	KadagalaDamodara Rao	P	A	P	P	P	P	P	P	P	P	P	P
23	21W61E0028	Karri Rambabu	P	P	P	P	A	P	P	P	P	P	P	P
24	21W61E0030	Kutikuppala Devi Prasad	P	P	P	P	P	P	A	P	P	P	P	P
25	21W61E0031	LavetiRaminaidu	P	P	P	P	P	A	P	P	P	P	P	P
26	21W61E0032	LocherlaNaresh	P	P	P	A	P	P	P	P	P	P	P	P
27	21W61E0035	Maruji Asha Jyothi	P	P	A	P	P	P	P	P	P	P	P	P
28	21W61E0036	Mirtivada Hari Babu	P	P	P	P	P	P	A	P	P	P	P	P
29	21W61E0037	MonangiShanmukha Rao	P	P	P	P	A	P	P	P	P	P	P	P
30	21W61E0039	NakkaMounika	P	P	P	P	P	P	P	P	A	P	P	P
31	21W61E0041	PanangipalliPrasoon	A	P	P	P	P	P	P	P	P	P	P	A
33	21W61E0042	Pappu Sandhya Rani	P	P	P	P	P	A	P	P	P	P	P	P
34	21W61E0043	PediredlaMadhuri Surya	P	A	P	P	P	P	P	P	P	P	P	P
35	21W61E0044	PotnuruBhagyaraj	P	P	P	P	P	P	P	P	P	A	P	P
36	21W61E0046	Rally Sai Kiran	P	P	A	P	P	P	P	P	P	P	P	P
37	21W61E0047	Sabbi Suresh	P	P	P	P	P	P	P	P	P	P	A	P
38	21W61E0048	SankabattulaSireesha	P	P	P	P	P	P	P	A	P	P	P	P
39	21W61E0049	SavaraEswararao	A	P	P	P	P	P	P	P	P	P	P	A
40	21W61E0050	SavaraSandeswara Rao	P	P	P	P	P	A	P	P	P	P	P	P
41	21W61E0051	Sheik Chandini	P	P	P	P	A	P	P	P	P	P	P	P
42	21W61E0052	SivalaBhagyam	P	P	P	P	P	P	P	P	P	P	A	P
43	21W61E0055	UritiVeeraVenkata Sai	P	P	P	P	P	P	P	P	A	P	P	P
44	21W61E0056	VoonaSireesha	P	P	P	P	P	P	P	P	P	P	P	A
45	21W61E0057	VysyarajuGoutham	P	A	P	P	P	P	P	P	P	P	P	P
46	22W61E0001	A.Venkata Surya Manimala	P	P	P	A	P	P	P	P	P	P	P	P



47	22W61E0002	Alupana Nikhil Reddi	P	P	P	P	P	P	P	P	A	P	P	P
48	22W61E0003	BaratamMohana Krishna	P	A	P	P	P	P	P	P	P	P	P	P
49	22W61E0004	BaratamRoshini	P	P	P	P	P	A	P	P	P	P	P	P
50	22W61E0005	BattaBuddeswararao	P	P	P	A	P	P	P	P	P	P	P	P
51	22W61E0006	Bendi Krishna Prasad	A	P	P	P	P	P	P	P	P	P	P	P
52	22W61E0007	BendiShravani	P	P	A	P	P	P	P	P	P	P	P	P
53	22W61E0008	CheediLokesh	P	P	P	P	A	P	P	P	P	P	P	P
54	22W61E0009	DaketiKrishnaveni	P	P	P	P	P	P	A	P	P	P	P	P
55	22W61E0010	Dakoju Sai Deepika	P	P	P	P	P	P	P	A	P	P	P	P
56	22W61E0011	Dannana Naveen	P	P	P	P	P	P	P	P	P	A	P	P
57	22W61E0012	DasariManikanta	P	P	P	P	P	A	P	P	P	P	P	P
58	22W61E0013	DesettiManoj Kumar	P	P	P	P	P	P	P	P	P	P	A	P
59	22W61E0014	DevupalliYernibabu	P	P	P	P	A	P	P	P	P	P	P	P
60	22W61E0015	DolaTarakarama Rao	P	P	P	P	P	P	A	P	P	P	P	P
61	22W61E0016	GanguTejeswara Rao	P	P	P	P	P	P	P	P	P	A	P	P
62	22W61E0017	GedalaAravinda Reddy	P	P	P	P	P	A	P	P	P	P	P	P
63	22W61E0018	Gollangi Prasad	A	P	P	P	P	P	P	P	P	P	P	P
64	22W61E0019	Gondu Lakshmana Rao	P	P	P	A	P	P	P	P	P	P	P	P
65	22W61E0020	GonduTilak	P	P	P	P	P	P	P	A	P	P	P	P
66	22W61E0021	GulipiliSateesh	P	A	P	P	P	P	P	P	P	P	P	P
67	22W61E0022	Gulivindala Sai	P	P	P	P	P	P	P	P	A	P	P	P
68	22W61E0023	GunupuramJagadeesh	P	P	A	P	P	P	P	P	P	P	P	P
69	22W61E0024	GunupuruSankara Rao	P	P	P	P	P	P	P	P	P	P	A	P
70	22W61E0025	Jada Suresh	P	P	P	P	P	P	P	P	P	P	P	A
71	22W61E0026	Jenjuluri Harish Kumar	P	P	P	P	P	P	P	P	P	A	P	P
72	22W61E0027	KadupukutlaRambabu	P	P	P	P	P	P	P	P	P	P	P	P
73	22W61E0028	Karri Shanmukarao	P	P	P	P	P	P	A	P	P	P	P	P

74	22W61E0029	KondalaLakshmanarao	P	P	P	P	P	P	A	P	P	P	P
75	22W61E0030	KondiPrameela	P	P	P	P	P	P	P	A	P	P	P
76	22W61E0031	Kranti Kumar Chowdary B	P	P	P	P	P	P	P	P	A	P	
77	22W61E0032	Kuna Sai Akshay	A	P	P	P	P	P	P	P	P	P	P
78	22W61E0034	MamidiManikanta	P	P	P	P	P	A	P	P	P	P	P
79	22W61E0035	Manda Jhansi	P	A	P	P	P	P	P	P	P	P	P
80	22W61E0036	MuddaSrinivasa Rao	P	P	A	P	P	P	P	P	P	P	P
81	22W61E0037	MungantiHaritha	P	P	P	A	P	P	P	P	P	P	P
82	22W61E0038	Nalli Vasu	P	P	P	P	A	P	P	P	P	P	P
83	22W61E0040	PillalaDevarao	P	P	P	P	P	P	P	P	A	P	P
84	22W61E0042	PonnanaSuguna	A	P	P	P	P	P	P	P	P	P	P
85	22W61E0043	PuttaGeetha	P	P	P	P	A	P	P	P	P	P	P
86	22W61E0044	Pydi Sai Chandra	P	P	P	P	P	P	A	P	P	P	P
87	22W61E0045	RunkanaMadhavi	P	P	A	P	P	P	P	P	P	P	P
88	22W61E0046	RunkanaUmamaheswara Rao	P	P	P	P	P	P	A	P	P	P	P
89	22W61E0047	SavaraAdinarayana	P	P	P	P	P	P	P	P	P	A	P
90	22W61E0048	Shiridi Naveen	P	P	P	P	P	P	P	A	P	P	P
91	22W61E0049	Siripurapu Ravi Teja	P	P	P	A	P	P	P	P	P	P	P
92	22W61E0050	TirumalapeddintiSrikanth	P	P	P	P	P	P	P	P	P	P	A
93	22W61E0051	UtlaTejaswi	P	P	P	P	A	P	P	P	P	P	P
94	22W61E0053	Vana Kiran Kumar	P	P	P	P	P	P	P	P	P	P	P
95	22W61E0054	Vavilapalli Rama Devi	P	P	P	P	P	P	A	P	P	P	P
96	22W61E0055	Yalakala Hari Krishna	P	P	P	P	P	P	P	P	P	A	P
97	22W61E0056	YendaYuva Kiran	P	P	P	P	P	P	P	P	P	P	P
Signature:			P	P	P	P	P	P	P	P	P	P	P

Program Co-ordinator

Head of the Department





# SRI SIVANI COLLEGE OF ENGINEERING

(Under the Management of Sri Sivani Educational Society, Srikakulam)  
(Approved by AICTE, New Delhi and Affiliated to JNTUGV, Vizianagaram-CC-W6,  
UGC Recognition under 2(f) & 12(B), ISO 9001:2015 Certified)  
NH-16, Chilakapalem Jn., Srikakulam Dist. Andhra Pradesh -532410

## Department of Management Studies

Academic year: 2022-23

Date: 10-01-2023

### PROGRAM REPORT

**Name of the program** : A Two-week Add-On Program on “Work-Life Balance”

**Program duration** : 26-12-2022to 07-01-2023

**Details of Resource Person** : Dr. PrasadaRao Bondada, M.B.A, PhD  
Associate Professor,  
Dept. of MBA,  
Sri Sivani College of Engineering  
[prasadaraobondada@gmail.com](mailto:prasadaraobondada@gmail.com),  
9912940557

**Details of Program coordinator** : Ms. Ramya, M.B.A  
Assistant Professor,  
Dept. of MBA  
Sri Sivani College of Engineering  
[vungatiramya@gmail.com](mailto:vungatiramya@gmail.com)  
9063303929

### **Objectives of the program:**

- To discuss common misconceptions regarding the topic of work-life balance.
- To study how to assess the different benefits associated with key work-life programs and practices.
- To know about re-conceptualization work-life balance programs as employee resources-allocation programs.
- To know how to assess the current state of balance in your life.
- To study how to develop strategies for balancing both work and personal life

**Topics covered:**

- Introduction to Work-Life Balance
- The problem of work-family imbalance in society
- Flexible work schedule and work-life balance
- The importance of work-life balance
- Studying and working balance
- Impact of work life balance on employees life
- The relations between employer flexibility& employee work life balance
- Correlation of employment and appropriate work life balance
- Work-life balance policies for employees and employers
- Key factors determining work-life balance
- The work life balance is a key to being best
- Review and conclusion

**Outcomes of the program:**

On completion of the course, student should be able to:

- It increases productivity of the company at the same time employees also.



- It improves personal physical and mental health and wellbeing.
- It also reduces the sickness and absenteeism.

**Number of participants : 97**

**Program Co-ordinator**



**Head of the Department**





# SRI SIVANI COLLEGE OF ENGINEERING

(Under the Management of Sri Sivani Educational Society, Srikakulam)  
(Approved by AICTE, New Delhi and Affiliated to JNTUGV, Vizianagaram-CC-W6,  
UGC Recognition under 2(f) & 12(B), ISO 9001:2015 Certified)  
NH-16, Chilakapalem Jn., Srikakulam Dist. Andhra Pradesh -532410

## DEPARTMENT OF MANAGEMENT STUDIES

### CERTIFICATE OF PARTICIPATION

THIS IS TO CERTIFY THAT MR./MS. GI. TILAK  
BEARING ROLL NO 22W61E0020 OF I YEAR I SEMESTER HAS COMPLETED  
A TWO-WEEK ADD-ON PROGRAM ON "WORK-LIFE BALANCE" DURING THE PERIOD  
26-12-2022 TO 07-01-2023.

  
Co-ordinator

  
HOD

  
Principal





# SRI SIVANI COLLEGE OF ENGINEERING

(Under the Management of Sri Sivani Educational Society, Srikakulam)  
(Approved by AICTE, New Delhi and Affiliated to JNTUGV, Vizianagaram-CC-W6,  
UGC Recognition under 2(f) & 12(B), ISO 9001:2015 Certified)  
NH-16, Chilakapalem Jn., Srikakulam Dist. Andhra Pradesh -532410

## DEPARTMENT OF MANAGEMENT STUDIES

### CERTIFICATE OF PARTICIPATION

THIS IS TO CERTIFY THAT MR./MS. D. SAI DEEPIKA.  
BEARING ROLL NO 22W61E0011 OF I YEAR I SEMESTER HAS COMPLETED  
A TWO-WEEK ADD-ON PROGRAM ON "WORK-LIFE BALANCE" DURING THE PERIOD  
26-12-2022 TO 07-01-2023.

  
Co-ordinator

  
HOD

  
Principal



# SRI SIVANI COLLEGE OF ENGINEERING

(Under the Management of Sri Sivani Educational Society, Srikakulam)  
(Approved by AICTE, New Delhi and Affiliated to JNTUGV, Vizianagaram-CC-W6,  
UGC Recognition under 2(f) & 12(B), ISO 9001:2015 Certified)  
NH-16, Chilakapalem Jn., SrikakulamDist -532410

Date: 27-01-2023

## CIRCULAR

This is to inform that the Department of Mechanical Engineering is organizing A **Two Week Add-on Program on "Drone technology"** from **6/2/2023 to 17/2/2023**. This program focuses on operation of a Drone and its key parts, Design and construction, Understanding dynamics, remote control, and navigation etc. Emphasizing safety protocols and legal compliance, Discovering how drones are used in industries, from agriculture to surveillance. In this regard, I suggest all 2<sup>nd</sup> year mechanical students to enroll this course on or before 1/2/2023.











**Venue:** Seminar hall, Block-1

**Coordinator:** Mr. M. Sai Krishna, Asst. Professor

Dept. of Mechanical Engineering

  
**Principal**  
PRINCIPAL  
SRI SIVANI COLLEGE OF ENGINEERING  
Chilakapalem Jn., SRIKAKULAM

### Copy to

Dept.	IQAC	Civil	EEE	Mech	ECE	CSE	H&BS	MBA	TPO	Office	Library
Signature											

CC To: The Management: for information.





# SRI SIVANI COLLEGE OF ENGINEERING

(Under the Management of Sri Sivani Educational Society, Srikakulam)  
(Approved by AICTE, New Delhi and Affiliated to JNTUGV, Vizianagaram-CC-W6,  
UGC Recognition under 2(f) & 12(B), ISO 9001:2015 Certified)  
NH-16, Chilakapalem Jn., Srikakulam Dist -532410

## Department of Mechanical Engineering

Academic Year: 2022 – 2023

Date: 27/01/2023

### PROGRAM SCHEDULE

Name of the Program: A Two Week Add-on Program on **Drone technology**.

S.NO	DATE	Topics to be covered
01	6/2/2023	Introduction to Drones
02	7/2/2023	Drone Components and Technologies
03	8/2/2023	Building a Drone from Scratch
04	9/2/2023	Aerodynamics and Drone Flight
05	10/2/2023	Remote Control and Navigation
06	11/2/2023	Safety Protocols and Best Practices
07	13/2/2023	Legal Regulations and Compliance
08	14/2/2023	Camera Systems and Imaging
09	15/2/2023	Sensors and Data Acquisition
10	16/2/2023	Industrial and Agricultural Applications
11	17/2/2023	Search and Rescue, Surveillance, and More

  
Program Coordinator

  
Head of the Department



### ABOUT THE INSTITUTION

Sri Sivani College of Engineering (SSCE) is one of the colleges functioning under Sri Sivani Educational Society, established in 2006 affiliated to JNTUGV, Vizianagaram, UGC Recognition under 2(f) & 12(B), ISO 9001:2015 Certified. SSCE is situated in a spacious 12 acres campus adjacent to NH-16 at Chilakapalem, Srikakulam, Andhra Pradesh.

SSCE offers B. Tech programs in Civil, C.S.E, E.E.E, E.C.E, Mechanical Engineering and PG programmes M.B.A, M.Tech and Diploma programmes for Civil, E.E.E and Mechanical Engineering. Fully connected through Fiber Optics and Wi-Fi Networks. Endowed with fully Qualified, well experienced and seasoned faculty members equipped with industrial experience and fully established laboratories with state-of-the-art technologies meets the growing needs of the students.

### ABOUT THE DEPARTMENT

SSCE started Mechanical Engineering programme in 2009. The Faculty in the department are in the track of excellence in terms of qualification and experience. Coming from various reputed universities, industries and research oriented organizations, faculty are committed to the noble cause of teaching learning process synchronizing with their efforts. It gives facilities to train in analytical, simulation, design and development and experimental techniques in the Capstone Project. Our department students are developing good research skills, technical and managerial skills which help them to become good technocrats in the society. The laboratories under various domains are fully equipped with up to date experimental facilities and machineries to train our students and to conduct research. Its got trained in Solid Edge design laboratory, AutoCAD, and ANSYS software. They are also trained in characterizing the microstructure of materials using optical microscope interfaced with image analyzer, hardness tester after making heat treatment such as quenching and tempering, induction hardening and normalizing. These kinds of laboratory trainings are very essential to work in various industries. The departmental project allows students to develop innovative concepts such as robot, automated cars and solar powered equipments and alternate fuel development etc.



Phantom quad copter



Quad copter

## PATRONS

Sri. V.M.M. Sainadh Reddy, President,  
Sri. J. Suryachandra Rao, Vice President,  
Sri. K. Durga Srinivas, Secretary,  
Sri. D. Venkata Rao, Treasurer,  
Sri. P. Durga Prasad Raju, Joint Secretary,  
Sri. S. Srinivasa Rao, Correspondent



### CHAIRMAN

**Dr. Y. Srinivasa Rao**  
Principal, SSCE

### ORGANISING COMMITTEE

**Dr. S. Laxmana Raju**  
Head of the Department

### Program Co-ordinator

**Mr. M. Sai Krishna, Assistant professor**  
Mobile: 8500363347  
Email: m.saikrishna340@gmail.com

### SRI SIVANI COLLEGE OF ENGINEERING

(Under the Management of Sri Sivani Educational Society, Srikakulam)  
(Approved by AICTE, New Delhi and Affiliated to JNTUGV, Vizianagaram-CC-W6, UGC Recognition under 2(f) & 12(B), ISO 9001:2015 Certified) NH-16, Chilakapalem Jn., Srikakulam Dist.532410

## SRI SIVANI COLLEGE OF ENGINEERING

### A Two-Week Add-On Program on "Drone Technology"

6/2/2023 to 17/2/2023

### ORGANIZED BY

DEPARTMENT OF MECHANICAL ENGINEERING





## ABOUT THE PROGRAM

We are excited to introduce our "Drone Technology" add-on program, thoughtfully tailored for the students of the Mechanical Engineering Department.

Drones have become integral to various industries, and this program aims to equip our students with the knowledge and practical skills required to excel in this exciting field.

### Resource Person

**Dr. V. Srinivasa Rao, M.Tech, PhD**  
mail: [yenda.srinivas@gmail.com](mailto:yenda.srinivas@gmail.com)  
mobile no: 9908840748

## PROGRAM CONTENT

**Drone Fundamentals:** Exploring the history, types and components of drones.

**Design and Construction:** Learning the principles of drone design and building a drone from scratch.

**Flight Principles:** Understanding aerodynamics, remote control, and navigation.

**Safety and Regulations:** Emphasizing safety protocols and legal compliance.

**Applications:-** Discovering how drones are used in industries, from agriculture to surveillance

## REGISTRATION FORM

### A TWO WEEK ADD-ON PROGRAM ON "DRONE TECHNOLOGY"

**Participant's Name:**

**Gender: Male/Female**

**Educational Qualifications:**

**Department:**

**Organization:**

**Address for Communication:**

**Phone No:**

**Email:**

**Date:**

**Signature of the Participant:**







# SRI SIVANI COLLEGE OF ENGINEERING

(Under the Management of Sri Sivani Educational Society, Srikakulam)  
(Approved by AICTE, New Delhi and Affiliated to JNTUGv, Vizianagaram-CC-W6,  
UGC Recognition under 2(f) & 12(B), ISO 9001:2015 Certified)  
NH-16, Chilakapalem Jn., SrikakulamDist -532410

## Department of Mechanical Engineering

Academic Year: 2022 – 2023

Date: 1/2/2023

### LIST OF ENROLLED STUDENTS

Name of the Program: A Two Week Add-on Program on Drone technology.

Sl.No	Roll.No.	Name of the Student	Year/Sem	Signature
1	21W61A0302	Boddu Chaitanya	II/II	B. chaitanya
2	21W61A0304	Chitti Soma shekhar	II/II	Ch. Soma Shekhar
3	21W61A0305	Kalamata Siva Sai Krishna	II/II	K. siva Sai
4	21W61A0306	Konki Janaki Ram	II/II	K. Janaki Ram
5	21W61A0307	Mandangi DurgaRao	II/II	M. Durga Rao
6	21W61A0308	Muddada. Prasanna Kumar	II/II	M. prasanna kumar
7	21W61A0309	Pydi Tejeswara rao	II/II	P. Tejeswara Rao
8	21W61A0310	Reddy Chandra Sekhar	II/II	R. Chandra sekhar
9	22W65A0301	A Suseel Srinivas	II/II	A.S. Suseel
10	22W65A0302	Bhupathi Lokesh	II/II	B. Lokesh
11	22W65A0303	Asi Sagar	II/II	A. Sagar
12	22W65A0304	Banala Suneel	II/II	B. Suneel
13	22W65A0305	Betha Sai Kiran	II/II	B. Sai Kiran
14	22W65A0306	Boddepalli Praveen	II/II	B. Praveen
15	22W65A0307	Bonangi Sunil Kumar	II/II	B. Sunil kumar
16	22W65A0308	Bora Venkatesh	II/II	B. Venkatesh
17	22W65A0309	Chalapakula Rajasekhar	II/II	C. Rajasekhar
18	22W65A0310	Chebrolu Eswara Rao	II/II	C. Eswara Rao
19	22W65A0311	Chitri Srinivasa rao	II/II	C. Srinivasa Rao
20	22W65A0312	Chittivalasa Saikiran	II/II	C. Saikiran
21	22W65A0313	Darapu GnaneshwaraRao	II/II	D. Gnaneshwara Rao
22	22W65A0314	Darapu Jogarao	II/II	D. Jogarao
23	22W65A0315	Vaidha Sai	II/II	M. Sai
24	22W65A0316	Era Nandini Proadhan	II/II	E. Nandini Proadhan
25	22W65A0317	Gollapalli Rajasekhara Rao	II/II	G. Raja Sekhar
26	22W65A0318	Gudla Sanjay kumar	II/II	G. Sanjay kumar
27	22W65A0319	Jallu Mahesh	II/II	J. Mahesh
28	22W65A0320	Kinjarapu Rammohan Naidu	II/II	K. Rammohan



29	22W65A0321	Kuna Yoganandh	II/II	K. Yoganandh
30	22W65A0322	Lolugu Prasad Kumar	II/II	L. Prasad Kumar
31	22W65A0323	Majji Kusumeswara Rao	II/II	M. Kusumeswara Rao
32	22W65A0324	Masupatri Yugandhar	II/II	M. Yugandhar
33	22W65A0325	Menda Sasi Kumar	II/II	M. Sasi Kumar
34	22W65A0326	Menda Srikanth	II/II	M. Srikanth
35	22W65A0327	Mukalla Mohan Rao	II/II	m. Mohan Rao
36	22W65A0328	Murapaka Naresh	II/II	m. Naresh
37	22W65A0329	O S N V S Revanth Kandhula	II/II	O S N V S Revanth
38	22W65A0330	Palakonda Srichandar	II/II	P. Srichandar
39	22W65A0331	Potnuru Venkata Srinivas	II/II	P. Venkata Srinivas
40	22W65A0332	Pundru Sai Venkata Ramana	II/II	P. Sai Venkata Ramana
41	22W65A0333	Ravada Upendra	II/II	R. Upendra
42	22W65A0334	Regana Kurmarao	II/II	R. Kurmarao
43	22W65A0335	Routhu Jaswanth	II/II	R. Jaswanth
44	22W65A0336	Sadhu Sankara Rao	II/II	S. Sankara Rao
45	22W65A0337	Siddhardha Mahanty	II/II	S. Mahanty
46	22W65A0338	Simma Harisimha naidu	II/II	S. Harisimha naidu
47	22W65A0339	Singapurapu Charan Kumar	II/II	S. Charan Kumar
48	22W65A0340	V Jaya Satya Chandra Sekhar	II/II	V. Sekhar

  
Program Co-ordinator

  
Head of the Department



# SRI SIVANI COLLEGE OF ENGINEERING

(Under the Management of Sri Sivani Educational Society, Srikakulam)  
 (Approved by AICTE, New Delhi and Affiliated to JNTUGV, Kakinada-CC-W6,  
 UGC Recognition under 2(f) & 12(B), ISO 9001:2015 Certified)  
 NH-16, Chilakapalem Jn., SrikakulamDist -532410

## Department of Mechanical Engineering

Academic Year: 2022–2023

### DAY-WISE ATTENDANCE SHEET

Name of the Program: A Two Week Add-on Program on Drone technology

Sl.No	Roll.No.	Name of the Student	01	02	03	04	05	06	07	08	09	10	11
			6/2	7/2	8/2	9/2	10/2	11/2	13/2	14/2	15/2	16/2	17/2
1	21W61A0302	Boddu Chaitanya	P	P	P	P	A	P	P	P	P	P	P
2	21W61A0304	Chitti Somashekhar	P	P	A	P	P	P	P	P	P	P	P
3	21W61A0305	Kalamata Siva Sai Krishna	P	P	P	P	A	P	P	P	P	P	P
4	21W61A0306	Konki Janaki Ram	A	P	P	P	P	P	P	P	P	P	P
5	21W61A0307	Mandangi DurgaRao	P	P	P	P	A	P	P	P	P	P	P
6	21W61A0308	Muddada. Prasanna Kumar	P	P	P	A	P	P	P	P	P	P	P
7	21W61A0309	Pydi Tejeswararao	P	A	P	P	P	P	P	P	P	P	P
8	21W61A0310	Reddy Chandra Sekhar	A	P	P	P	P	P	P	P	P	P	P
9	22W65A0301	A Suseel Srinivas	P	P	P	A	P	P	P	P	P	P	P
10	22W65A0302	Bhupathi Lokesh	A	P	A	P	P	P	P	P	P	P	P
11	22W65A0303	Asi Sagar	P	P	P	P	A	P	P	P	P	P	P
12	22W65A0304	Banala Suneel	A	P	P	P	P	P	P	P	P	A	P
13	22W65A0305	Betha Sai Kiran	P	P	P	A	P	P	P	P	P	P	P
14	22W65A0306	Boddepalli Praveen	P	P	A	P	P	P	P	P	P	P	P
15	22W65A0307	Bonangi Sunil Kumar	P	A	P	P	P	P	P	P	P	P	P
16	22W65A0308	Bora Venkatesh	P	P	P	P	A	P	P	P	P	P	P
17	22W65A0309	Chalapakula Rajasekhar	P	P	A	P	P	P	P	P	P	P	P
18	22W65A0310	Chebrolu EswaraRao	P	P	P	P	A	P	P	P	P	P	P
19	22W65A0311	Chitri Srinivasa rao	P	P	P	P	P	P	P	P	P	P	P
20	22W65A0312	Chittivalasa Saikiran	P	A	P	P	P	P	P	P	P	P	P
21	22W65A0313	Darapu GnaneswaraRao	A	P	P	P	P	P	P	A	P	P	P
22	22W65A0314	Darapu Jogarao	P	P	P	A	P	P	P	P	P	P	P
23	22W65A0315	Vaidha Sai	P	P	P	A	P	P	P	P	P	P	P
24	22W65A0316	Era Nandini Prodhan	P	A	P	P	P	P	P	P	P	P	P
25	22W65A0317	Gollapalli Rajasekhara Rao	P	P	P	A	P	P	P	P	A	P	P
26	22W65A0318	Gudla Sanjay kumar	P	P	A	P	P	P	P	P	P	P	P
27	22W65A0319	Jallu Mahesh	P	P	P	P	A	P	P	P	P	P	P



Sl.No	Roll.No.	Name of the Student	01	02	03	04	05	06	07	08	09	10	11
			6/2	7/2	8/2	9/2	10/2	11/2	12/2	13/2	14/2	15/2	16/2
28	22W65A0320	Kinjarapu Rammohan Naidu	P	P	P	A	P	P	P	P	P	P	P
29	22W65A0321	Kuna Yoganandh	A	P	P	P	P	P	P	P	A	P	P
30	22W65A0322	Lolugu Prasad Kumar	P	P	P	P	A	P	P	P	P	P	P
31	22W65A0323	Majji Kusumeswara Rao	P	A	P	P	P	P	P	P	P	P	P
32	22W65A0324	Masupatri Yugandhar	P	P	P	A	P	P	P	P	P	P	P
33	22W65A0325	MendaSasi Kumar	P	P	A	P	P	P	P	P	P	P	P
34	22W65A0326	MendaSrikanth	A	P	P	P	P	P	P	P	P	P	P
35	22W65A0327	Mukalla Mohan Rao	P	P	P	A	P	P	P	P	P	P	P
36	22W65A0328	MurapakaNaresh	P	A	P	P	P	P	P	P	P	P	P
37	22W65A0329	O S N V S RevanthKandhula	P	P	A	P	P	P	P	P	P	P	P
38	22W65A0330	Palakonda Srichandar	P	P	P	A	P	P	P	P	P	P	P
39	22W65A0331	Potnuru Venkata Srinivas	P	A	P	P	P	P	P	P	P	P	P
40	22W65A0332	Pundru Sai Venkata Ramana	P	P	P	P	A	P	P	P	P	P	P
41	22W65A0333	Ravada Upendra	P	P	P	P	P	P	P	P	P	P	P
42	22W65A0334	Regana Kurmara O	P	P	A	P	P	P	P	P	P	P	P
43	22W65A0335	Routhu Jaswanth	P	P	P	A	P	P	P	P	P	P	P
44	22W65A0336	Sadhu SankaraRao	P	A	P	P	P	P	P	P	P	P	P
45	22W65A0337	Siddhardha Mahanty	P	P	P	P	A	P	P	P	P	P	P
46	22W65A0338	Simma Hari simhanaidu	P	P	A	P	P	P	P	P	P	P	P
47	22W65A0339	Singupurapu Charan Kumar	A	P	P	P	P	P	P	P	P	P	P
48	22W65A0340	V JSatya Chandra Sekhar	P	P	P	A	P	P	P	P	P	P	P
Signature			M.S	M.S	M.S	M.S	M.S	M.S	M.S	M.S	M.S	M.S	M.S

*M. Sai K.*  
Program Coordinator

  
Head of the Department



# SRI SIVANI COLLEGE OF ENGINEERING

(Under the Management of Sri Sivani Educational Society, Srikakulam)  
(Approved by AICTE, New Delhi and Affiliated to JNTUGV, Vizianagaram-CC-W6,  
UGC Recognition under 2(f) & 12(B), ISO 9001:2015 Certified)  
NH-16, Chilakapalem Jn., Srikakulam Dist. Andhra Pradesh -532410

## Department of Mechanical Engineering

Academic Year: 2022 – 2023

Date: 24/02/2023

### PROGRAM REPORT

<b>Name of the Program</b>	:A Two week Add-on Program on Drone technology
<b>Program Duration</b>	: Two weeks (6/2/2023 to 17/2/2023, 11days)
<b>Resource Person Details</b>	: Dr. Y. SrinivasaRao, M.Tech, PhD. Principal, Mechanical Engg. Department Sri Sivani College of Engineering,
<b>Program Coordinator Details</b>	: Mr.M.Sai Krishna, M.Tech Asst. Professor, Mechanical Department Sri Sivani College of Engineering, Srikakulam Contact number: 7981244957.
<b>Program Venue</b>	: Seminar hall, SSCE Block-1

### **Program Objectives:**

- To familiarize students with drone technology,
- To familiarize drone applications.
- To familiarize drones impact on various industries.
- To prepare students for opportunities in the growing field of drones and unmanned aerial vehicles.

### **Topics Covered:-**

1. Introduction to Drone Technology
2. Types of Drones and Their Applications
3. Drone Components and Systems
4. Drone Aerodynamics and Flight Mechanics
5. Remote Sensing with Drones
6. Drone Navigation and Control
7. Drone Sensors and Imaging Technologies



8. Drone Data Acquisition and Processing
9. Regulatory Framework for Drones
10. Safety and Security in Drone Operations
11. Drones in Agriculture and Crop Monitoring
12. Drones in Search and Rescue Operations
13. Surveillance and Monitoring with Drones
14. Drone Swarms and Cooperative Control
15. Case Studies in Industrial Drone Applications
16. Emerging Technologies in Drone Industry
17. Environmental Monitoring with Drones
18. Drones in Construction and Infrastructure
19. Drone-based Delivery Systems
20. Future Developments in Drone Technology



**Program Outcomes:**

Upon completion of this course the student will be able to:

- Recognize the significance of drone technology in a variety of applications.
- Explore Drone Design and Construction.
- Understand Drone Flight Principles
- Adhere to Drone Safety and Regulations
- Examine Drone Imaging and Sensing
- Analyze Drone Applications
- Gain insights into career opportunities and advancements in the drone industry.

**Number of Students attended : 48**

*M. Saik*  
**Program Coordinator**

  
**Head of the Department**



# SRI SIVANI COLLEGE OF ENGINEERING

(Under the Management of Sri Sivani Educational Society, Srikakulam)  
(Approved by AICTE, New Delhi and Affiliated to JNTUGV, Vizianagaram-CC-W6,  
UGC Recognition under 2(f) & 12(B), ISO 9001:2015 Certified)  
NH-16, Chilakapalem Jn., Srikakulam Dist. Andhra Pradesh -532410

## Certificate of Participation

This is to certify that Mr./Ms. R. KURMA RAO bearing roll no 22W65A0334

of II Year 2<sup>nd</sup> Semester has completed A Two Week Add-On Program on "Drone technology" during

the period 6/2/2023 to 17/2/2023 organised by Mechanical Engineering Department

*M. Saikrishna*  
CO-ORDINATOR

*[Signature]*  
HOD

*[Signature]*  
PRINCIPAL





# SRI SIVANI COLLEGE OF ENGINEERING

(Under the Management of Sri Sivani Educational Society, Srikakulam)  
(Approved by AICTE, New Delhi and Affiliated to JNTUGV, Vizianagaram-CC-W6,  
UGC Recognition under 2(f) & 12(B), ISO 9001:2015 Certified)  
NH-16, Chilakapalem Jn., Srikakulam Dist. Andhra Pradesh -532410

## Certificate of Participation

This is to certify that Mr./Ms. BODDU CHAITANYA bearing roll no 21W61A0302

of II Year 2<sup>nd</sup> Semester has completed A Two Week Add-On Program on "Drone technology" during

the period 6/2/2023 to 17/2/2023 organised by Mechanical Engineering Department

*M. Sai Kiran*  
CO-ORDINATOR

*[Signature]*  
HOD

*[Signature]*  
PRINCIPAL



# SRI SIVANI COLLEGE OF ENGINEERING

(Under the Management of Sri Sivani Educational Society, Srikakulam)  
(Approved by AICTE, New Delhi and Affiliated to JNTUGV, Vizianagaram-CC-W6,  
UGC Recognition under 2(f) & 12(B), ISO 9001:2015 Certified)  
NH-16, Chilakapalem Jn., Srikakulam Dist. Andhra Pradesh -532410

## Certificate of Participation

This is to certify that Mr./Ms. BORA VENKATESH bearing roll no 22W6SA0308

of II Year 2<sup>nd</sup> Semester has completed A Two Week Add-On Program on "Drone technology" during

the period 6/2/2023 to 17/2/2023 organised by Mechanical Engineering Department

  
CO-ORDINATOR

  
HOD

  
PRINCIPAL





# SRI SIVANI COLLEGE OF ENGINEERING

(Under the Management of Sri Sivani Educational Society, Srikakulam)  
(Approved by AICTE, New Delhi and Affiliated to JNTUGV, Vizianagaram-CC-W6,  
UGC Recognition under 2(f) & 12(B), ISO 9001:2015 Certified)  
NH-16, Chilakapalem Jn., Srikakulam Dist. Andhra Pradesh -532410

Date: 4-02-2023

## CIRCULAR

This is to inform that the Department of Electronics & Communication Engineering is organizing **A Two Week Add-On Program on "VSAT-Principals of Satellite Communication"** during **13-02-2023 TO 25-02-2023** to the 2<sup>nd</sup> year ECE students to enhance their skills applicable for job opportunities. VSAT stands for Very Small Aperture Terminal. VSAT is of importance, especially in remote areas such as the hilly mountain regions, where Internet connectivity cannot be directly provided. There is no option left in such places through which the Internet can be accessed anyway In this regard, I suggest all the students to enroll for this course on or before 9<sup>th</sup> February 2023.

**Venue:** VLSI Lab, Block – 2, SSCE.

**Co-ordinator:** Mrs.M.AMALA, Asst. Prof,

Department of Electronics & Communication Engineering

**Principal -**  
**PRINCIPAL**  
SRI SIVANI COLLEGE OF ENGINEERING,  
Chilakapalem Jn., SRIKAKULAM

### Copy to

Dept.	IQAC	Civil	EEE	MECH	ECE	CSE	H&BS	MBA	TPO	Office	Library
Signature											

CC To: The Management: for information.



# SRI SIVANI COLLEGE OF ENGINEERING

(Under the Management of Sri Sivani Educational Society, Srikakulam)  
(Approved by AICTE, New Delhi and Affiliated to JNTUGV, Vizianagaram-CC-W6,  
UGC Recognition under 2(f) & 12(B), ISO 9001:2015 Certified)  
NH-16, Chilakapalem Jn., Srikakulam Dist. Andhra Pradesh -532410

## Department of Electronics and Communication Engineering

Academic Year : 2022-23

Date: 04-02-2023

Name of the Program: A Two Week Add-on Program on VSAT-Principals of Satellite Communication

### PROGRAM SCHEDULE

S.NO	DATE	TOPICS TO BE COVERED
1	13-02-2023	V-SAT Introduction
2	14-02-2023	V-SAT Hub
3	15-02-2023	FDMA, TDMA, CDMA
4	16-02-2023	Different Access Methods Used In VSAT Communication
5	17-02-2023	Coding and modulation
6	20-02-2023	Typical V-SAT Installation
7	21-02-2023	Communication Satellite: Orbit and Description
8	22-02-2023	Satellite Sub-Systems
9	23-02-2023	Propagation Effects
10	24-02-2023	Earth Station Technology
11	25-02-2023	Satellite Packet Communications

Program Co-ordinator

Head of the Department



## ABOUT THE INSTITUTION

Sri Sivani College of Engineering (SSCE) is one of the colleges functioning under Sri Sivani Educational Society, established in 2006 affiliated to JNTUGV, Vizianagaram. UGC Recognition under 2(f) & 12(B), ISO 9001:2015 Certified. SSCE is situated in a spacious 12 acres campus adjacent to NH-16 at Chilakapalem, Srikakulam, Andhra Pradesh. SSCE offers B. Tech programs in Civil, C.S.E, E.E.E, E.C.E, Mechanical Engineering and PG programmes M.B.A, M.Tech and Diploma programmes for Civil, E.E.E and Mechanical Engineering. Fully connected through Fiber Optics and Wi-Fi Networks. Endowed with fully Qualified, well experienced and seasoned faculty members equipped with industrial experience and fully established laboratories with state-of-the-art technologies meets the growing needs of the students.

## ABOUT THE DEPARTMENT

The Department of Electronics and Communications Engineering was established in the academic year 2006-07 with an annual intake of 60. Since its commencement, the primary objective of the department has been to impart quality education, training and research at the undergraduate levels in Electronics and Communication Engineering with broad emphasis on design aspects of electronic systems.

The intake was increased to 120 from the academic year 2008-09. Five batches of students have graduated so far. The Department is offering two M.Tech courses Digital Electronics & Communication Systems and VLSI (VLSI). The first PG program DECS (Digital Electronics and Communication Systems) was started in the year 2010. The rapid developments in the field of Electronics triggered the inception of another PG programme on VLSI in the year 2011.

The Department has sufficient spacious classrooms, well-equipped laboratories with an excellent infrastructure. The department has conducted many technical symposiums under the societies of IETE, ISTE and student association named MICROS (Minds of Innovative Communicative and Resplendent Organizing Society) and also has a close interaction with the alumni where their inputs are being used continuously for the improvement of curriculum.

## PATRONS

Sri. V.M.M. Sainadh Reddy, President,  
Sri. J. Suryachandra Rao, Vice President,  
Sri. K. Durga Srinivas, Secretary,  
Sri. D. Venkata Rao, Treasurer,  
Sri. P. Durga Prasad Raju, Joint Secretary,  
Dr.S. Srinivasa Rao, Correspondent,



## CHAIRMAN

Dr. Y. Srinivasa Rao,  
Principal, SSCE

## ORGANISING COMMITTEE

Dr.V.Suryanarayana  
Head of the Department  
Program Co-ordinator

Mrs. M.Amala, Assistant professor  
Mobile: 7032564114  
Email: amalamatsa005@gmail.com

## SRI SIVANI COLLEGE OF ENGINEERING

(Under the Management of Sri Sivani Educational Society, Srikakulam)

(Approved by AICTE, New Delhi and Affiliated to JNTUGV, Vizianagaram-CC-W6)

UGC Recognition under 2(f) & 12(B), ISO 9001:2015 Certified) NH-16, Chilakapalem Jn, Srikakulam Dist Andhra Pradesh -532410

## SRI SIVANI COLLEGE OF ENGINEERING

A Two-Week Add-On Program  
on "VSAT-Principals of  
Satellite Communication"



13-02-2023 to 25 -02-2023

ORGANIZED BY  
DEPARTMENT OF ELECTRONICS AND  
COMMUNICATION ENGINEERING





## Objectives of the program:

VSAT stands for Very Small Aperture Terminal. VSAT is of importance, especially in remote areas such as the hilly mountain regions, where Internet connectivity cannot be directly provided. There is no option left in such places through which the Internet can be accessed anyway. These places could be the Ocean region and the Sea region, where the citizens have a lack of utilities. In such cases, VSAT is one of the technologies that make Internet Connectivity possible so that people can access it. All the work is carried out in a workstation group where the sending and receiving of signals takes place. The data such as audio, video, etc. can be sent and received. Therefore, VSAT is considered to be a private Earth Station. This Earth Station is designed in a way such that the signals are transmitted and received with the help of satellites.



### Resource Person

Mr.K.Vijaya Krishna,M.Tech  
koradavijay425@gmail.com  
8498860741,SSCE

## PROGRAM CONTENT

- V-SAT Introduction
- V-SAT Hub
- FDMA, TDMA, CDMA
- Different Access Methods Used In VSAT Communication
- Coding and modulation
- VSATs in the Indian context
- Typical V-SAT Installation
- Communication Satellite: Orbit and Description
- Satellite Sub-Systems
- Propagation Earth Station
- Technology on Effects
- Satellite Packet Communications

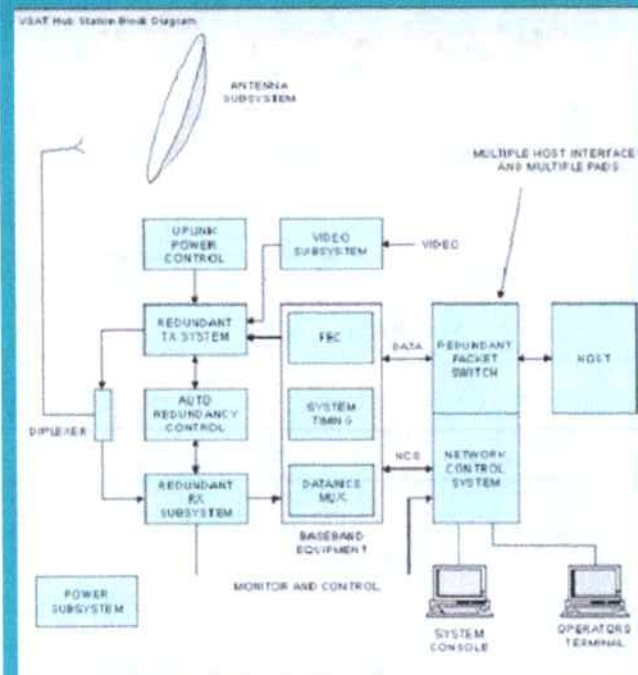

## REGISTRATION FORM

### A TWO-WEEK ADD-ON PROGRAM ON "VSAT-PRINCIPALS OF SATELLITE COMMUNICATION"

Participant's Name:

Gender: Male/Female

Educational Qualifications:

Department:

Organization:

Address for Communication:

Phone No:

Email:

Date:

Signature of the Participant:





# SRI SIVANI COLLEGE OF ENGINEERING

(Under the Management of Sri Sivani Educational Society, Srikakulam)  
(Approved by AICTE, New Delhi and Affiliated to JNTUGV, Vizianagaram-CC-W6,  
UGC Recognition under 2(f) & 12(B), ISO 9001:2015 Certified)  
NH-16, Chilakapalem Jn., Srikakulam Dist. Andhra Pradesh -532410

## Department of Electronics and Communication Engineering

Academic Year : 2022-23

DATE: 13-02-2023

Name of the Program: A Two Week Add-On Program on VSAT-Principals of Satellite Communication

### List of Enrolled Students

S.NO	ROOL NO	NAME OF THE STUDENT	YEAR-SEM	SIGNATURE
1	21W61A0401	Allada Dhayanandha	II-II	A. Dhayanandha
2	21W61A0402	Allu Yamini	II-II	A. Yamini
3	21W61A0403	Beesetti Teja	II-II	B. Teja
4	21W61A0404	Behara Vidya Kalyan	II-II	B. Vidya Kalyan
5	21W61A0405	Bodda Kranthi	II-II	B. Kranthi
6	21W61A0406	Bommali Grishma	II-II	B. Grishma
7	21W61A0408	Chitti Venkatesh	II-II	C. Venkatesh
8	21W61A0409	D Rohit Kumar	II-II	D. Rohit Kumar
9	21W61A0410	Darapu Hemanth	II-II	D. Hemanth
10	21W61A0411	Dasari Manikanta	II-II	D. Manikanta
11	21W61A0412	Dumpala Satwik	II-II	D. Satwik
12	21W61A0413	Dunga Bhanuprakash	II-II	D. Bhanu Prakash
13	21W61A0414	Dunga Sasi Kumar	II-II	D. Sasikumar
14	21W61A0415	Ganteda Madhu Latha	II-II	G. Madhu Latha
15	21W61A0416	Gedela Ganesh	II-II	G. Ganesh
16	21W61A0417	Gedela Raviteja	II-II	G. Raviteja
17	21W61A0418	Gorle Satyavathi	II-II	G. Satyavathi
18	21W61A0419	Guruvu Mounika	II-II	G. mounika
19	21W61A0420	Ippili Anusha	II-II	J. Anusha
20	21W61A0421	Ippili Pavan Kumar	II-II	P. pavan kumar
21	21W61A0425	Konti Anesha	II-II	k. Anesha
22	21W61A0426	Kunchala Sravani	II-II	k. Sravani
23	21W61A0427	Narala Vijay	II-II	N. Vijaya

24	21W61A0428	Panga Akhildandeswari	II-II	P. Akhildandeswari
5	21W61A0429	Pariga Hemanth	II-II	P. Hemanth
26	21W61A0430	Pasarla Tareesh	II-II	P. Tareesh
27	21W61A0431	Pilla Kiran Kumar	II-II	F. Kiran Kumar
28	21W61A0432	Pogirir Bhargavi	II-II	P. Bhargavi
29	21W61A0433	Polaki Pavan	II-II	P. Pavan
30	21W61A0434	Potti Tanuja	II-II	P. Tanuja
31	21W61A0435	Raavi Sai Priyanka	II-II	R. Sai Priyanka
32	21W61A0436	Ragala Lakshmi	II-II	R. Lakshmi
33	21W61A0437	Ravada Jagadeesh	II-II	R. Jagadeesh
34	21W61A0438	Rokkam Deepika	II-II	R. Deepika
35	21W61A0439	Samantula Sai Eswara Rao	II-II	S. Eswara Rao
36	21W61A0440	Sarlana Pradeep	II-II	S. Pradeep
37	21W61A0441	Sativada Rohini	II-II	S. Rohini
38	21W61A0442	Simma Ganesh	II-II	S. Ganesh
39	21W61A0443	Simma Jayaram	II-II	S. Jayaram
40	21W61A0444	Suravarapu Haritha	II-II	S. Haritha
41	21W61A0445	Thandroth Pravalika	II-II	T. Pravalika
42	21W61A0446	Ulasa Madhu	II-II	U. Madhu
43	22W65A0401	Asi Nitin	II-II	A. Nitin
44	22W65A0402	Balaga Anushka	II-II	B. Anushka
45	22W65A0403	C Hymavathi	II-II	C. Hymavathi
46	22W65A0404	Divvalsa Yogeswararao	II-II	D. Yogeswararao
47	22W65A0405	G Chandana Sowjanya	II-II	G. Chandana Sowjanya
48	22W65A0406	Gudivada Rishikumar	II-II	G. Rishikumar
49	22W65A0407	Gudla Surya Shanmukha	II-II	Surya & Shanmukha
50	22W65A0408	Ippili Kusuma	II-II	I. Kusuma
51	22W65A0409	Kanithi Navya	II-II	K. Navya
52	22W65A0410	Kurimina Srinu	II-II	K. Srinu
53	22W65A0411	Muntha Teja	II-II	M. Teja
54	22W65A0412	Sappa Anitha	II-II	S. Anitha
55	22W65A0413	Simhadri Praveen	II-II	S. Praveen

  
Program Co-ordinator

  
Head of the Department





# SRI SIVANI COLLEGE OF ENGINEERING

(Under the Management of Sri Sivani Educational Society, Srikakulam)  
 (Approved by AICTE, New Delhi and Affiliated to JNTUGV, Vizianagaram-CC-W6,  
 UGC Recognition under 2(f) & 12(B), ISO 9001:2015 Certified)  
 NH-16, Chilakapalem Jn., Srikakulam Dist. Andhra Pradesh -532410

## Department Of Electronics and Communication Engineering

Academic year : 2022-23

Name of the Program: A Two Week Add-On Program on VSAT-Principals of Satellite Communication

### DAY WISE ATTENDANCE SHEET

S.NO	ROOL NO	NAME OF THE STUDENT	1 13 <sup>th</sup>	2 14 <sup>th</sup>	3 15 <sup>th</sup>	4 16 <sup>th</sup>	5 17 <sup>th</sup>	6 20 <sup>th</sup>	7 21 <sup>st</sup>	8 22 <sup>nd</sup>	9 23 <sup>rd</sup>	10 24 <sup>th</sup>	11 25 <sup>th</sup>
1	21W61A0401	Allada Dhayanandha	P	P	P	P	P	P	P	P	P	P	P
2	21W61A0402	Allu Yamini	P	P	P	P	P	P	P	P	P	P	P
3	21W61A0403	Beesetti Teja	P	P	P	P	P	P	P	P	P	P	P
4	21W61A0404	Behara Vidya Kalyan	P	P	P	P	P	P	P	P	P	P	P
5	21W61A0405	Bodda Kranthi	AB	P	P	P	P	P	P	P	P	P	P
6	21W61A0406	Bommali Grishma	P	P	P	P	P	P	P	P	P	P	P
7	21W61A0408	Chitti Venkatesh	P	P	P	P	P	P	P	P	P	P	P
8	21W61A0409	D Rohit Kumar	P	P	P	P	P	P	P	P	P	P	P
9	21W61A0410	Darapu Hemanth	P	P	P	P	P	AB	P	P	P	P	P
10	21W61A0411	Dasari Manikanta	P	P	P	P	P	P	P	P	P	P	P
11	21W61A0412	Dumpala Satwik	P	P	P	P	P	P	P	P	P	P	P
12	21W61A0413	Dunga Bhanuprakash	P	P	P	P	P	P	P	P	P	P	P
13	21W61A0414	Dunga Sasi Kumar	P	P	P	P	P	P	P	P	P	P	P
14	21W61A0415	Ganteda Madhu Latha	P	P	P	P	P	P	P	P	P	P	P
15	21W61A0416	Gedela Ganesh	P	P	P	P	P	P	P	P	P	P	P
16	21W61A0417	Gedela Raviteja	P	P	P	P	P	P	P	P	P	AB	P
17	21W61A0418	Gorle Satyavathi	P	P	P	P	P	P	P	P	P	P	P
18	21W61A0419	Guruvu Mounika	P	P	P	P	P	P	P	P	P	P	P
19	21W61A0420	Ippili Anusha	P	P	P	P	P	P	P	P	P	P	P
20	21W61A0421	Ippili Pavan Kumar	P	P	P	P	P	P	P	P	P	P	P
21	21W61A0425	Konti Anesha	P	P	P	P	P	P	P	P	P	P	P
22	21W61A0426	Kunchala Sravani	P	P	P	P	P	AB	P	P	P	P	P



23	21W61A0427	Narala Vijay	P	P	P	P	P	P	P	P	P	P
24	21W61A0428	Panga Akhilandeswari	P	P	P	P	P	P	P	P	P	P
25	21W61A0429	Pariga Hemanth	P	P	P	P	P	P	P	P	P	P
26	21W61A0430	Pasarla Tareesh	P	P	P	P	P	P	P	AB	P	P
27	21W61A0431	Pilla Kiran Kumar	P	P	P	P	P	P	P	P	P	P
28	21W61A0432	Pogirir Bhargavi	P	P	P	P	P	P	P	P	P	P
29	21W61A0433	Polaki Pavan	P	P	P	P	P	P	P	P	P	P
30	21W61A0434	Potti Tanuja	P	P	P	P	P	P	P	P	P	P
31	21W61A0435	Raavi Sai Priyanka	P	P	P	P	P	P	P	P	P	P
32	21W61A0436	Ragala Lakshmi	P	P	P	P	P	P	P	P	P	P
33	21W61A0437	Ravada Jagadeesh	P	AB	P	P	P	P	P	P	P	P
34	21W61A0438	Rokkam Deepika	P	P	P	P	P	P	P	P	P	P
35	21W61A0439	S.Sai Eswara Rao	P	P	P	P	P	P	P	P	P	P
36	21W61A0440	Sarlana Pradeep	P	P	P	P	P	P	P	P	P	P
37	21W61A0441	Sativada Rohini	P	P	P	P	P	P	P	P	P	P
38	21W61A0442	Simma Ganesh	P	P	P	P	P	P	P	P	P	P
39	21W61A0443	Simma Jayaram	P	P	P	P	AB	P	P	P	P	P
40	21W61A0444	Suravarapu Haritha	P	P	P	P	P	P	P	P	P	P
41	21W61A0445	Thandroth Pravalika	P	P	P	P	P	P	P	P	P	P
42	21W61A0446	Ulasa Madhu	P	P	P	P	P	P	P	P	P	P
43	22W65A0401	Asi Nitin	P	P	P	P	P	P	P	P	P	P
44	22W65A0402	Balaga Anushka	P	P	P	P	P	P	P	P	P	P
45	22W65A0403	C Hymavathi	P	P	P	P	P	P	P	P	P	P
46	22W65A0404	D Yogeswararao	P	P	P	P	P	P	P	P	P	P
47	22W65A0405	G Chandana Sowjanya	P	P	P	P	P	P	P	AB	P	P
48	22W65A0406	Gudivada Rishikumar	P	P	P	P	P	P	P	P	P	P
49	22W65A0407	G Surya Shanmukha	P	P	P	P	P	P	P	P	P	P
50	22W65A0408	Ippili Kusuma	P	P	P	P	P	P	P	P	P	P
51	22W65A0409	Kanithi Navya	P	P	P	P	P	P	P	P	P	P
52	22W65A0410	Kurimina Srinu	P	P	P	P	P	P	P	P	P	P
53	22W65A0411	Muntha Teja	P	P	P	P	P	P	P	P	P	P
54	22W65A0412	Sappa Anitha	P	P	AB	P	P	P	P	P	P	P
55	22W65A0413	Simhadri Praveen	P	P	P	P	P	P	P	P	P	P
Signature												

  
Program Co-ordinator

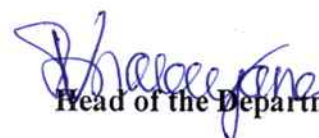
  
Head of the Department





# SRI SIVANI COLLEGE OF ENGINEERING

(Under the Management of Sri Sivani Educational Society, Srikakulam)  
(Approved by AICTE, New Delhi and Affiliated to JNTUGV, Vizianagaram-CC-W6,  
UGC Recognition under 2(f) & 12(B), ISO 9001:2015 Certified)  
NH-16, Chilakapalem Jn., Srikakulam Dist. Andhra Pradesh -532410

## Department of Electronics and Communication Engineering

Academic Year: 2022-23

DATE: 27-02-2023

### PROGRAM REPORT

**Name of the Program** : A Two Week Add-On Program on VSAT-Principals  
of Satellite Communication

**Program Duration** : 13-02-2023 TO 25-02-2023

**Name of the Resource Person & Details:** Mr.K.Vijaya Krishna, M.Tech

Assistant Professor

Dept. of E.C.E, koradavijay425@gmail.com

8498860741

**Details of the Program Coordinator** : Mrs.M.Amala, M.Tech

Assistant Professor,

Dept. of E.C.E, amalamatsa005@gmail.com

7032564114

### **Objectives of the program:**

- A very small aperture terminal (VSAT) is a data transmission technology used for many types of data management and in high-frequency trading.
- VSAT can be used in place of a large physical network as it bounces the signal from satellites instead of being transported through physical means like an ethernet connection.
- Because the signal needs to bounce, there can be a latency issue that wouldn't exist with a physical network. However, most users feel this is the price you pay for remote access and less infrastructure and consider it a fair trade.
- Weather can adversely impact the efficacy of a VSAT network.



**Topics covered:**

- V-SAT Introduction
- V-SAT Hub
- FDMA, TDMA, CDMA
- Different Access Methods Used In VSAT Communication
- Coding and modulation
- VSATs in the Indian context
- Typical V-SAT Installation
- Communication Satellite: Orbit and Description
- Satellite Sub-Systems



- Propagation Effects
- Earth Station Technology
- Satellite Packet Communications

**Outcomes of the program:**

- A very small aperture terminal (VSAT) is a small-sized earth station used in the transmit/receive of data, voice and video signals over a satellite communication network, excluding broadcast television.
- A VSAT consists of two parts: a transceiver placed outdoors in direct line of sight to the satellite, and a device that is placed indoors to interface the transceiver with the end user's communications device, such as a PC.
- The transceiver receives or sends a signal to a satellite transponder in the sky. The satellite sends and receives signals from a ground station computer that acts as a hub for the system.

**Number of Participants: 55**



**Program Co-ordinator**



# SRI SIVANI COLLEGE OF ENGINEERING

(Under the Management of Sri Sivani Educational Society, Srikakulam)  
(Approved by AICTE, New Delhi and Affiliated to JNTUGV, Vizianagaram-CC-W6,  
UGC Recognition under 2(f) & 12(B), ISO 9001:2015 Certified)  
NH-16, Chilakapalem Jn., Srikakulam Dist. Andhra Pradesh -532410

## CERTIFICATE OF PARTICIPATION

This is to certify that Mr./Ms. N. Vijay  
bearing Roll no 21061A0427 of II Year II Semester has completed A  
Two Week Add-On Program on “V-SAT Principles of Satellite Communication ” during  
the period **13-02-2023 to 25-03-2023** organized by Department of Electronics and  
Communication Engineering.

  
Co-ordinator

  
HOD

  
Principal





# SRI SIVANI COLLEGE OF ENGINEERING

(Under the Management of Sri Sivani Educational Society, Srikakulam)  
(Approved by AICTE, New Delhi and Affiliated to JNTUGV, Vizianagaram-CC-W6,  
UGC Recognition under 2(f) & 12(B), ISO 9001:2015 Certified)  
NH-16, Chilakapalem Jn., Srikakulam Dist. Andhra Pradesh -532410

## CERTIFICATE OF PARTICIPATION

This is to certify that Mr./Ms. A. Yamini

bearing Roll no 21W61A0402 of II Year II Semester has completed A  
Two Week Add-On Program on “V-SAT Principles of Satellite Communication ” during  
the period **13-02-2023** to **25-03-2023** organized by Department of Electronics and  
Communication Engineering.

  
Co-ordinator

  
HOD

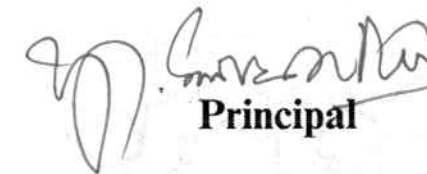
  
Principal



# SRI SIVANI COLLEGE OF ENGINEERING

(Under the Management of Sri Sivani Educational Society, Srikakulam)  
(Approved by AICTE, New Delhi and Affiliated to JNTUGV, Vizianagaram-CC-W6,  
UGC Recognition under 2(f) & 12(B), ISO 9001:2015 Certified)  
NH-16, Chilakapalem Jn., Srikakulam Dist. Andhra Pradesh -532410

## CERTIFICATE OF PARTICIPATION

This is to certify that Mr./Ms. B. Teja

bearing Roll no 216261A0403 of II Year II Semester has completed A  
Two Week Add-On Program on “V-SAT Principles of Satellite Communication ” during  
the period **13-02-2023 to 25-03-2023** organized by Department of Electronics and  
Communication Engineering.

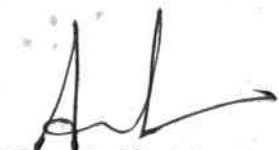
  
Co-ordinator

  
HOD

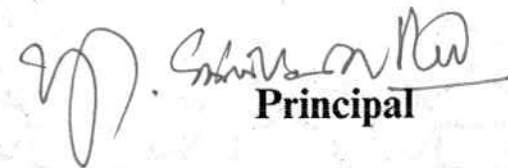
  
Principal





# SRI SIVANI COLLEGE OF ENGINEERING

(Under the Management of Sri Sivani Educational Society, Srikakulam)  
(Approved by AICTE, New Delhi and Affiliated to JNTUGV, Vizianagaram-CC-W6,  
UGC Recognition under 2(f) & 12(B), ISO 9001:2015 Certified)  
NH-16, Chilakapalem Jn., Srikakulam Dist. Andhra Pradesh -532410

Date: 27-02-2023

## CIRCULAR

Here by informed to all the students of MBA, that the Department of Management Studies is planning to organize **A Two-week Add-On Program on "Mergers and Takeover"** from **13-03-2023 to 25-03-2023**. This program is aimed at enhancing your skills and knowledge in the field of Mergers and takeover it involves merging of two or more companies, also it involves one large company how it takeover a small company. In this regard, I suggest all the 1<sup>st</sup> and 2<sup>nd</sup> year MBA students to enroll this program on or before **03-03-2023**.

Venue: MBA Class Room, Block – 3, SSCE.

Co-ordinator: Mrs.Ch. Keerthana, Asst. Prof,

Department of Management Studies

  
Principal  
PRINCIPAL  
SRI SIVANI COLLEGE OF ENGINEERING  
Chilakapalem Jn., SRIKAKULAM

Copy to

Dept.	IQAC	Civil	EEE	Mech	ECE	CSE	H&BS	MBA	TPO	Office	Library
Signature											

CC To: The Management: for information.



# SRI SIVANI COLLEGE OF ENGINEERING

(Under the Management of Sri Sivani Educational Society, Srikakulam)  
(Approved by AICTE, New Delhi and Affiliated to JNTUGV, Vizianagaram-CC-W6,  
UGC Recognition under 2(f) & 12(B), ISO 9001:2015 Certified)  
NH-16, Chilakapalem Jn., Srikakulam Dist. Andhra Pradesh -532410

## Department of Management Studies

Academic Year: 2022-23

Date: 27-02-2023

Name of the program: A Two-week Add-On Program on "Mergers and Takeover"

### PROGRAM SCHEDULE

S.no	Date	Topics To Be Covered
1	13-03-2023	Introduction To Mergers And Takeover, Types Of Mergers
2	14-03-2023	General Mergers
3	15-03-2023	Parent-Subsidiary Mergers
4	16-03-2023	Triangular Mergers
5	17-03-2023	Multi-Entity Mergers
6	18-03-2023	Types Of Takeovers
7	20-03-2023	Friendly Takeovers
8	21-03-2023	Hostile Takeovers
9	23-03-2023	Reverse Takeovers
10	24-03-2023	Back Flips Takeover
11	25-03-2023	Review And Conclusion

Program Co-ordinator

Head of the Department



## About the Institution

Sri Sivani College of Engineering was established in the year 2006 by the highly motivated and philanthropic personalities well noted in the Srikakulam district for their commitment and concern for upliftment of education. The College recognizes the vital need to produce competent engineering professionals and techno managerial professionals for the development of country. It is spread over 11.10 acres of land, with picturesque landscape providing calm learning atmosphere. The campus is eco-friendly and an ideal location for studies. The institution is established as a co-educational institution and affiliated to JNTUGV, Vizianagaram.

The Management believes in the three principles for the success of true education based on discipline, dedication and commitment. Here the environment is free from all limitations and tensions. The institution aims at achieving excellence in engineering education, not only at basic level but also at advanced levels. Sri Sivani is the abode where the experienced faculty with their broader vision set their goals to fulfill the dreams of the students with better employability skills. Campus recruitments are often conducted by inviting renowned companies. Healthy atmosphere pervades within and outside the campus. Competitive spirit is encouraged among the students. Every year students are presented with meritorious awards and gold medals based on their performance.



## PATRONS

**Sri V.M.M. SAINADH REDDY,**  
President

**Sri J. SURYACHANDRA RAO,**  
Vice President

**Sri K. DURGA SRINIVAS,**  
Secretary

**Sri D. VENKATA RAO,**  
Treasurer

**Sri P. DURGA PRASAD RAJU,**  
Joint Secretary

**Sri S. SRINIVASA RAO,**  
Correspondent

## CHAIRMAN

**Dr. Y.Srinivasa Rao,**  
Principal, SSCE

## ORGANISING COMMITTEE

**Mr. K. Ravi Kumar**

**Head of the Department**

**Department of Management Studies**

**Program Co-ordinator**

**Mrs. Ch.Keerthana,**

**Assistant professor**

**Mobile: 8464816827**

**Email: keerthanach505@gmail.com**

## Sri Sivani College of Engineering

(Under the Management of Sri Sivani Educational Society, Srikakulam) Approved by AICTE, New Delhi and Affiliated to JNTUGV, Vizianagaram-CC-W6, UGC Recognition under 2(f) & 12(B), ISO 9001:2015 Certified) NH-16, Chilakapalem Jn., Srikakulam Dist. Andhra Pradesh -532410



**A Two-Week Add-On Program on  
"Mergers And Takeover"  
13-03-2023 to 25-03-2023**

**Organized**

**By**

**Department of Management Studies**

# Mergers and Takeovers

MERGERS AND TAKEOVERS





## **ABOUT THE DEPARTMENT**

The Department of management studies was established in the academic year 2008 with an annual intake of 60. The Department is offering full time two year post graduation course since inception of the Institution. The Department focuses on preparing the students for wide range of management careers equipping them with unique enriching experience of molding tomorrow's technocrats with high caliber and commitment.

## **MASTER OF BUSINESS ADMINISTRATION**

MBA. in finance, marketing, human resource management includes study of various aspects to meet the requirements of the various industries. The course contains study of the basic administration and its application, as well as the detailed study of the various aspects of its working. the course of in master of business administration trains an individual in the fields related to finance, marketing, human resource management and its industry.

## **RESOURCE PERSON**

Mr. K. Ravi Kumar, MBA, MHRM.  
Associate professor,  
Dept. of MBA  
Sri Sivani College of Engineering  
ravi.karnayina@gmail.com  
9392069779

## **PROGRAM CONTENT**

1. Introduction to mergers and takeover
2. Types of mergers
3. General mergers
4. Parent-subsidiary mergers
5. Triangular mergers
6. Multi-entity mergers
7. Types of takeovers
8. Friendly takeovers
9. Hostile takeovers
10. Reverse takeovers
11. Back flips takeover
12. Review and conclusion



## **REGISTRATION FORM**

### **A Two-week Add-On Program on "Mergers And Takeover"**

**Participant's Name:**

**Gender: Male/Female**

**Educational Qualifications:**

**Department:**

**Organization:**

**Address for Communication:**

**Phone No:**

**Email:**

**Date:**

**Signature of the Participant:**





# SRI SIVANI COLLEGE OF ENGINEERING

(Under the Management of Sri Sivani Educational Society, Srikakulam)  
(Approved by AICTE, New Delhi and Affiliated to JNTUGV, Vizianagaram-CC-W6,  
UGC Recognition under 2(f) & 12(B), ISO 9001:2015 Certified)  
NH-16, Chilakapalem Jn., Srikakulam Dist. Andhra Pradesh -532410

## Department of Management Studies

Academic Year: 2022-23

Date: 03-03-2023

Name of the program: A Two-Week Add-On Program on "Mergers and Takeover"

### List of Enrolled Students

S.no	Roll no	Name of the Student	Year-Sem	Signature
1	21W61E0001	Allu Shirisha	II-II	A. shirisha
2	21W61E0003	Bammidi Tulasidas	II-II	B. Tulasidas
3	21W61E0004	Banna Jayaram	II-II	B. Jayaram
4	21W61E0005	Baratam Sai Eswar	II-II	B. sai Eswar
5	21W61E0006	Basetti Pushpa	II-II	B. Pushpa
6	21W61E0007	Behara Neelima	II-II	B. Neelima
7	21W61E0009	Boddepalli Harika	II-II	B. harika
8	21W61E0010	Botsa Ganesh	II-II	B. Ganesh
9	21W61E0011	Buridi Yugandhar	II-II	B. Yugandhar
10	21W61E0012	Butcha Venkata Ramana Reddy	II-II	B. V. R. Reddy
11	21W61E0013	Dupplapuri Hari Babu	II-II	D. Hari Babu
12	21W61E0014	Dandupati Rajasekhar	II-II	D. Rajasekhar
13	21W61E0015	Dasari Anil	II-II	D. Anil
14	21W61E0016	Duppada Mounika	II-II	D. Mounika
15	21W61E0018	Goddu Dilleswara Rao	II-II	G. Dilleswara Rao
16	21W61E0019	Gudla Divakar	II-II	G. Divakar
17	21W61E0020	Guntrothu Amruth Kumar	II-II	G. Amruth Kumar
18	21W61E0021	Ijjada Durga Prasad	II-II	I. Durga Prasad
19	21W61E0022	Jaddu Prasadu	II-II	J. Prasadu
20	21W61E0023	Jamma Sudheer Kumar	II-II	J. Sudheer Kumar
21	21W61E0025	K.S.V.V.S.Narayana Murthy	II-II	K.S.V.V.S. Narayana Murthy
22	21W61E0026	Kadagala Damodara Rao	II-II	K. Damodara Rao

23	21W61E0028	Karri Rambabu	II-II	K. Rambabu
24	21W61E0030	Kutikuppala Devi Prasad	II-II	K. Devi Prasad
25	21W61E0031	Laveti Raminaidu	II-II	L. Raminaidu
26	21W61E0032	Locherla Naresh	II-II	L. Naresh
27	21W61E0035	Maruji Asha Jyothi	II-II	M. Asha Jyothi
28	21W61E0036	Mirtivada Hari Babu	II-II	M. Hari Babu
29	21W61E0037	Monangi Shanmukha Rao	II-II	M. Shanmukha Rao
30	21W61E0039	Nakka Mounika	II-II	N. Mounika
31	21W61E0041	Panangipalli Prasoon	II-II	P. Prasoon
33	21W61E0042	Pappu Sandhya Rani	II-II	P. Sandhya Rani
34	21W61E0043	Pediredla Madhuri Surya	II-II	P. Madhuri Surya
35	21W61E0044	Potnuru Bhagyaraj	II-II	P. Bhagyaraj
36	21W61E0046	Rally Sai Kiran	II-II	R. Sai Kiran
37	21W61E0047	Sabbi Suresh	II-II	S. Suresh
38	21W61E0048	Sankabattula Sireesha	II-II	S. Sireesha
39	21W61E0049	Savara Eswararao	II-II	S. Eswararao
40	21W61E0050	Savara Sandeswara Rao	II-II	S. Sandeswara Rao
41	21W61E0051	Sheik Chandini	II-II	S. Chandini
42	21W61E0052	Sivala Bhagyam	II-II	S. Bhagyam
43	21W61E0055	Uriti Veera Venkata Sai	II-II	U. Sireesha
44	21W61E0056	Voona Sireesha	II-II	V. Sireesha
45	21W61E0057	Vysyaraju Goutham	II-II	V. Goutham
46	22W61E0001	A. Venkata Surya Manimala	I-I	A. Surya
47	22W61E0004	Baratam Roshini	I-I	B. Roshini
48	22W61E0005	Batta Buddeswararao	I-I	B. Buddeswararao
49	22W61E0006	Bendi Krishna Prasad	I-I	B. Krishna Prasad
50	22W61E0007	Bendi Shravani	I-I	B. Shravani
51	22W61E0009	Daketi Krishnaveni	I-I	D. Krishnaveni
52	22W61E0010	Dakaju Sai Deepika	I-I	D. Sai Deepika
53	22W61E0011	Dannana Naveen	I-I	D. Naveen
54	22W61E0012	Dasari Manikanta	I-I	D. Manikanta
55	22W61E0013	Desetti Manoj Kumar	I-I	D. Manoj Kumar
56	22W61E0014	Devupalli Yernibabu	I-I	D. Yernibabu



57	22W61E0015	Dola Tarakarama Rao	I-I	T. Tarakarama Rao
58	22W61E0016	Gangu Tejeswara Rao	I-I	G. Tejeswara Rao
59	22W61E0017	Gedala Aravinda Reddy	I-I	G. Aravinda Reddy
60	22W61E0018	Gollangi Prasad	I-I	G. Prasad
61	22W61E0019	Gondu Lakshmana Rao	I-I	G. Lakshmana Rao
62	22W61E0020	Gondu Tilak	I-I	G. Tilak
63	22W61E0022	Gulivindala Sai	I-I	G. Sai
64	22W61E0023	Gunupuram Jagadeesh	I-I	G. Jagadeesh
65	22W61E0024	Gunupuru Sankara Rao	I-I	G. Sankara Rao
66	22W61E0025	Jada Suresh.	I-I	J. Suresh.
67	22W61E0026	Jenjului Harish Kumar	I-I	J. Harish Kumar
68	22W61E0027	Kadupukutla Rambabu	I-I	K. Rambabu
69	22W61E0028	Karri Shanmukarao	I-I	K. Shanmukarao
70	22W61E0029	Kondala Lakshmanarao	I-I	K. Lakshmanarao
71	22W61E0030	Kondi Prameela	I-I	K. Prameela
72	22W61E0031	Kranti Kumar Chowdary B	I-I	<del>K. Prameela</del>
73	22W61E0032	Kuna Sai Akshay	I-I	K. Sai Akshay
74	22W61E0034	Mamidi Manikanta	I-I	M. Manikanta
75	22W61E0035	Manda Jhansi	I-I	M. Jhansi
76	22W61E0036	Mudda Srinivasa Rao	I-I	M. Srinivasarao
77	22W61E0037	Munganti Haritha	I-I	M. Haritha
78	22W61E0038	Nalli Vasu	I-I	N. Vasu.
79	22W61E0040	Pillala Devarao	I-I	P. Devarao
80	22W61E0043	Putta Geetha	I-I	P. Geetha
81	22W61E0044	Pydi Sai Chandra	I-I	P. Sai chandra
82	22W61E0045	Runkana Madhavi	I-I	R. Madhavi
83	22W61E0046	Runkana Umamaheswara Rao	I-I	<del>R. Madhavi</del>
84	22W61E0047	Savara Adinarayana	I-I	S. Adinarayana
85	22W61E0049	Siripurapu Ravi Teja	I-I	S. Raviteja
86	22W61E0050	Tirumalapeddinti Srikanth	I-I	T. Srikanth
87	22W61E0051	Utla Tejaswi	I-I	U. Tejaswi
88	22W61E0053	Vana Kiran Kumar	I-I	V. Kiran
89	22W61E0054	Vavilapalli Rama Devi	I-I	V. Ramadevi

90	22W61E0055	Yalakala Hari Krishna	I-I	Y. Hanisrisha
91	22W61E0056	Yenda Yuva Kiran	I-I	Y. Yevakir

  
Program Co-ordinator

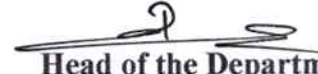
  
Head of the Department













75	22W61E0030	KondiPrameela	P	P	P	P	P	P	P	P	P	P	P
76	22W61E0031	Kranti Kumar Chowdary B	P	A	P	P	P	P	P	P	P	P	P
77	22W61E0032	Kuna Sai Akshay	P	P	P	P	P	P	P	P	P	P	P
78	22W61E0034	MamidiManikanta	P	P	P	P	P	P	P	P	P	P	P
79	22W61E0035	Manda Jhansi	P	P	P	P	P	P	P	P	P	P	P
80	22W61E0036	MuddaSrinivasa Rao	P	P	P	P	P	P	P	P	P	P	P
81	22W61E0037	MungantiHaritha	P	A	P	P	P	P	P	P	P	P	P
82	22W61E0038	Nalli Vasu	P	P	P	P	P	P	P	P	P	P	P
83	22W61E0040	PillalaDevarao	P	P	P	P	P	P	P	P	P	P	P
84	22W61E0042	PonnanaSuguna	P	A	P	P	P	P	P	P	P	P	P
85	22W61E0043	PuttaGeetha	P	P	P	P	P	P	P	P	P	P	P
86	22W61E0044	Pydi Sai Chandra	P	A	P	P	P	P	P	P	P	P	P
87	22W61E0045	RunkanaMadhavi	P	P	P	P	P	P	P	P	P	P	P
88	22W61E0046	RunkanaUmamaheswara Rao	P	P	P	P	P	P	P	P	P	P	P
89	22W61E0047	SavaraAdinarayana	P	P	P	P	P	P	P	P	P	P	P
90	22W61E0048	Shiridi Naveen	A	P	P	P	P	P	P	P	P	P	P
91	22W61E0049	Siripurapu Ravi Teja	P	P	P	P	P	P	P	P	P	P	P
92	22W61E0050	TirumalapeddintiSrikanth	P	P	P	P	P	P	P	P	P	P	P
93	22W61E0051	UtlaTejaswi	P	P	P	P	P	P	P	P	P	P	P
94	22W61E0053	Vana Kiran Kumar	P	P	P	P	P	P	P	P	P	P	P
95	22W61E0054	Vavilapalli Rama Devi	P	P	P	P	P	P	P	P	P	P	P
96	22W61E0055	Yalakala Hari Krishna	P	P	P	P	P	P	P	P	P	P	P
97	22W61E0056	YendaYuva Kiran	P	P	P	P	P	P	P	P	P	P	P
Signature:													

  
Program Co-ordinator

  
Head of the Department





# SRI SIVANI COLLEGE OF ENGINEERING

(Under the Management of Sri Sivani Educational Society, Srikakulam)  
(Approved by AICTE, New Delhi and Affiliated to JNTUGV, Vizianagaram-CC-W6,  
UGC Recognition under 2(f) & 12(B), ISO 9001:2015 Certified)  
NH-16, Chilakapalem Jn., Srikakulam Dist. Andhra Pradesh -532410

## Department of Management Studies

Academic year: 2022-23

Date: 28-03-2023

### PROGRAM REPORT

**Name of the program** : A Two-week Add-On Program on “Mergers and Takeover”

**Program duration** : 13-03-2023 to 25-03-2023

**Details of Resource Person** : Mr. K. Ravi Kumar, MBA, MHRM.

Associate professor,  
Dept. of MBA  
Sri Sivani College of Engineering  
ravi.karnayina@gmail.com  
9392069779

**Details of Program coordinator** : Mrs. Ch. Keerthana, M.B.A

Assistant Professor,  
Dept. of MBA  
Sri Sivani College of Engineering  
[keerthanach505@gmail.com](mailto:keerthanach505@gmail.com)

9347603309

### **Objectives of the program:**

- To study how mergers and takeovers expand the economy.
- To study how it increasing market capitalization.
- To know how a loss-making company that merges with a profit making company can achieve growth.

### Topics covered:

- Introduction to mergers and takeover
- Types of mergers
- General mergers
- Parent-subsidiary mergers
- Triangular mergers
- Multi-entity mergers
- Types of takeovers
- Friendly takeovers
- Hostile takeovers
- Reverse takeovers
- Back flips takeover
- Review and conclusion





**Outcomes of the program:**

On completion of the course, student should be able to:

- It increases access to capital.
- It results lower costs as a result of higher volume.
- It gives better bargaining power with distributors, and more.
- It increases market share in sensex.

**Number of participants : 91**

**Program Co-ordinator**



**Head of the Department**





# SRI SIVANI COLLEGE OF ENGINEERING

(Under the Management of Sri Sivani Educational Society, Srikakulam)  
(Approved by AICTE, New Delhi and Affiliated to JNTUGV, Vizianagaram-CC-W6,  
UGC Recognition under 2(f) & 12(B), ISO 9001:2015 Certified)  
NH-16, Chilakapalem Jn., Srikakulam Dist. Andhra Pradesh -532410

## DEPARTMENT OF MANAGEMENT STUDIES

### CERTIFICATE OF PARTICIPATION

THIS IS TO CERTIFY THAT MR./MS. A. VENKATA SURYA MANIMALA  
BEARING ROLL NO 221W61E0001 OF I YEAR I SEMESTER HAS COMPLETED  
A TWO-WEEK ADD-ON PROGRAM ON "MERGERS AND TAKEOVER" DURING THE PERIOD  
13-03-2023 TO 25-03-2023.

  
Co-ordinator

  
HOD

  
Principal





# SRI SIVANI COLLEGE OF ENGINEERING

(Under the Management of Sri Sivani Educational Society, Srikakulam)  
(Approved by AICTE, New Delhi and Affiliated to JNTUGV, Vizianagaram-CC-W6,  
UGC Recognition under 2(f) & 12(B), ISO 9001:2015 Certified)  
NH-16, Chilakapalem Jn., Srikakulam Dist. Andhra Pradesh -532410

## DEPARTMENT OF MANAGEMENT STUDIES

### CERTIFICATE OF PARTICIPATION

THIS IS TO CERTIFY THAT MR./MS. P. GEETHA  
BEARING ROLL NO 22W61E0043 OF I YEAR I SEMESTER HAS COMPLETED  
A TWO-WEEK ADD-ON PROGRAM ON "MERGERS AND TAKEOVER" DURING THE PERIOD  
13-03-2023 TO 25-03-2023.

  
Co-ordinator

  
HOD

  
Principal



# SRI SIVANI COLLEGE OF ENGINEERING

(Under the Management of Sri Sivani Educational Society, Srikakulam)  
(Approved by AICTE, New Delhi and Affiliated to JNTUGV, Vizianagaram-CC-W6,  
UGC Recognition under 2(f) & 12(B), ISO 9001:2015 Certified)  
NH-16, Chilakapalem Jn., Srikakulam Dist. Andhra Pradesh -532410

## DEPARTMENT OF MANAGEMENT STUDIES

### CERTIFICATE OF PARTICIPATION

THIS IS TO CERTIFY THAT MR./MS. B. Tulasidas  
BEARING ROLL NO 21W61E0003 OF II YEAR II SEMESTER HAS COMPLETED  
A TWO-WEEK ADD-ON PROGRAM ON "MERGERS AND TAKEOVER" DURING THE PERIOD  
13-03-2023 TO 25-03-2023.

  
Co-ordinator

  
HOD

  
Principal





# SRI SIVANI COLLEGE OF ENGINEERING

(Under the Management of Sri Sivani Educational Society, Srikakulam)  
(Approved by AICTE, New Delhi and Affiliated to JNTUGV, Vizianagaram-CC-W6,  
UGC Recognition under 2(f) & 12(B), ISO 9001:2015 Certified)  
NH-16, Chilakapalem Jn., Srikakulam Dist. Andhra Pradesh -532410

## DEPARTMENT OF MANAGEMENT STUDIES

### CERTIFICATE OF PARTICIPATION

THIS IS TO CERTIFY THAT MR./MS. ALLU. SHIRISHA  
BEARING ROLL NO 21W61E0001 OF II YEAR II SEMESTER HAS COMPLETED  
A TWO-WEEK ADD-ON PROGRAM ON "MERGERS AND TAKEOVER" DURING THE PERIOD  
13-03-2023 TO 25-03-2023.

  
Co-ordinator

  
HOD

  
Principal



# SRI SIVANI COLLEGE OF ENGINEERING

(Under the Management of Sri Sivani Educational Society, Srikakulam)  
(Approved by AICTE, New Delhi and Affiliated to JNTUGV, Vizianagaram-CC-W6,  
UGC Recognition under 2(f) & 12(B), ISO 9001:2015 Certified)  
NH-16, Chilakapalem Jn., Srikakulam Dist. Andhra Pradesh -532410

## DEPARTMENT OF MANAGEMENT STUDIES

### CERTIFICATE OF PARTICIPATION

THIS IS TO CERTIFY THAT MR./MS. P.PRASOONA  
BEARING ROLL NO 21W61E0041 OF II YEAR II SEMESTER HAS COMPLETED  
A TWO-WEEK ADD-ON PROGRAM ON "MERGERS AND TAKEOVER" DURING THE PERIOD  
13-03-2023 TO 25-03-2023.

  
Co-ordinator

  
HOD

  
Principal





# SRI SIVANI COLLEGE OF ENGINEERING

(Under the Management of Sri Sivani Educational Society, Srikakulam)  
(Approved by AICTE, New Delhi and Affiliated to JNTUGV, Vizianagaram-CC-W6,  
UGC Recognition under 2(f) & 12(B), ISO 9001:2015 Certified)  
NH-16, Chilakapalem Jn., Srikakulam Dist. Andhra Pradesh -532410

Date: 20-03-2023

## CIRCULAR

The Department of Civil Engineering is happy to announce about conducting A Two-Week Add-On program on **Construction Planning using Primavera P6** for the benefit of final year Civil Students. This program is schedule from **27-03-2023 to 06-04-2023** in the Central Computing Lab, Block I. Primavera is a project management tool useful for Civil Engineers with resource management, risk reduction and corporate growth projection. I do inform all the final year civil students to register this program on or before 25-03-2023 and gain practical knowledge which will be helpful to you in the quest of job.

**Venue:** Central Computing Lab, Block – 1, SSCE.

**Co-ordinator:** Mr. P. Jagadeeshwara Rao, Asst. Prof,  
Department of Civil Engineering

Principal

PRINCIPAL  
SRI SIVANI COLLEGE OF ENGINEERING  
Chilakapalem Jn., SRIKAKULAM

### Copy to

Dept.	IQAC	Civil	EEE	Mech	ECE	CSE	H&BS	MBA	TPO	Office	Library
Signature											

CC To: The Management: for information.



# SRI SIVANI COLLEGE OF ENGINEERING

(Under the Management of Sri Sivani Educational Society, Srikakulam)  
(Approved by AICTE, New Delhi and Affiliated to JNTUGV, Vizianagaram-CC-W6,  
UGC Recognition under 2(f) & 12(B), ISO 9001:2015 Certified)  
NH-16, Chilakapalem Jn., Srikakulam Dist. Andhra Pradesh -532410

## Department of Civil Engineering

Academic year: 2022-23

Date: 20-03-2023

Name of the program: A Two-Week Add-On Program on “Construction Planning using Primavera P6”

### PROGRAM SCHEDULE

S NO	Date	Topic To Be Covered
1	27-03-2023	<ul style="list-style-type: none"><li>• An overview of Project Schedule Management</li><li>• Fundamentals of Project Management</li><li>• What is a Project?</li><li>• What is Project Management?<ul style="list-style-type: none"><li>○ Five Process Groups of Project Management</li><li>○ Schedule and its Importance</li><li>○ Critical Path Method for Scheduling</li><li>○ Understanding a Gantt chart</li></ul></li></ul>
2	28-03-2023	<ul style="list-style-type: none"><li>• Introduction to Primavera Systems and Oracle Primavera P6 PPM</li><li>• Primavera P6 Installation</li><li>• Primavera P6 Interface and Preferences</li><li>• Organizational Breakdown Structure</li><li>• Enterprise Project Structure</li><li>• Work Breakdown Structure</li></ul>
3	29-03-2023	<ul style="list-style-type: none"><li>• Planning your Work Schedule</li><li>• Understanding a Sample Project</li><li>• Creating a New Project in Primavera P6</li><li>• Project Window Options</li><li>• Understanding Project Must Finish and Total Float Roof</li></ul>
4	31-03-2023	<ul style="list-style-type: none"><li>• Role of Calendars in Scheduling</li><li>• Understanding and Adding Calendars</li><li>• Project and Database Default Calendar</li><li>• Creating WBS in Primavera P6</li></ul>
5	01-04-2023	<ul style="list-style-type: none"><li>• Understanding Percentage Complete Types</li><li>• Understanding Activity Types</li><li>• Setting Defaults for New Activities</li><li>• Adding Activities</li><li>• Estimating Duration of Activities</li><li>• Adding Duration of Activities</li></ul>



6	02-04-2023	<ul style="list-style-type: none"> <li>• Understanding Relationships</li> <li>• Adding Relationships and Scheduling</li> <li>• Understanding Scheduling Algorithm</li> <li>• Scheduling Options</li> </ul>
7	03-04-2023	<ul style="list-style-type: none"> <li>• Formatting Bars, Columns and Timescale</li> <li>• Group, Sorts and Layouts</li> <li>• Filtering in Primavera P6</li> <li>• Printing, Exporting and Importing</li> <li>• Reporting in Primavera P6</li> </ul>
8	04-04-2023	<ul style="list-style-type: none"> <li>• Understanding and Adding Baseline</li> <li>• Updating a Project</li> <li>• Assigning Baselines and Monitoring a Project</li> <li>• Adding and Assigning New Currency</li> </ul>
9	05-04-2023	<ul style="list-style-type: none"> <li>• Understanding Roles, Resources and Expenses</li> <li>• Adding Resources</li> <li>• Duration Types in Primavera P6</li> <li>• Assigning Resources and Reviewing Resource Allocation</li> </ul>
10	06-04-2023	<ul style="list-style-type: none"> <li>• Adding Expenses</li> <li>• Developing Project Funding Requirements and Cost S-curve</li> <li>• Updating a Project with Resources and Expenses</li> <li>• Question and Answers</li> <li>• Discussion on Final Reports</li> </ul>

*P. Jagadeeshwar*  
**Program Co-ordinator**

*Parm*  
**Head of the Department**

### About the Institution

Sri Sivani College of Engineering was established in the year 2006 by the highly motivated and philanthropic personalities well noted in the Srikakulam district for their commitment and concern for upliftment of education. The College recognizes the vital need to produce competent engineering professionals and techno managerial professionals for the development of country. It is spread over 11.10 acres of land, with picturesque landscape providing calm learning atmosphere. The campus is eco-friendly and an ideal location for studies. The institution is established as a co-educational institution and permanently affiliated to JNTUK, Kakinada.



The Management believes in the three principles for the success of true education based on discipline, dedication and commitment. Here the environment is free from all limitations and tensions. The institution aims at achieving excellence in engineering education, not only at basic level but also at advanced levels. Sri Sivani is the abode where the experienced faculty with their broader vision set their goals to fulfill the dreams of the students with better employability skills. Campus recruitments are often conducted by inviting renowned companies. Healthy atmosphere pervades within and outside the campus. Competitive spirit is encouraged among the students. Every year students are presented with meritorious awards and gold medals based on their performance.

### PATRONS

**Sri V.M.M. SAINADH REDDY,**  
President,  
**Sri J. SURYACHANDRA RAO,**  
Vice President,  
**Sri K. DURGA SRINIVAS,**  
Secretary,  
**Sri D. VENKATA RAO,**  
Treasurer,  
**Sri P. DURGA PRASAD RAJU,**  
Joint Secretary,  
**Sri S. SRINIVASA RAO,**  
Correspondent

### CHAIRMAN

**Dr. Y Srinivasa Rao, Principal,**  
Sri Sivani College of Engineering

### Organizing Committee

**CONVENOR**  
**Mr. G Parasuram,**  
Head of the Department,  
Department of Civil Engineering  
parsuram.gadi@gmail.com  
8978060684

**P Jagadeeshwara Rao**  
M.Tech – Structural Engineering  
Asst. Professor  
Department of Civil Engineering  
SSCE, Chilakapalem  
Jagadeeshrao266@gmail.com  
8179048756



## Sri Sivani College of Engineering

(Under the Management of Sri Sivani Educational Society, Srikakulam)  
(Approved by AICTE, New Delhi & Affiliated to JNTUGV, Vizianagaram  
CC-W6, UGC Recognition under 2(f) & 12(B), ISO 9001:2015 Certified)  
NH-16, Chilakapalem Jn., Srikakulam Dist. Andhra Pradesh -532410

### A Two-Week Add- On Program on "Construction Planning using Primavera P6"

27<sup>th</sup> March - 6<sup>th</sup> April 2019

Organized  
By

Department of Civil Engineering

## Primavera P6 Course

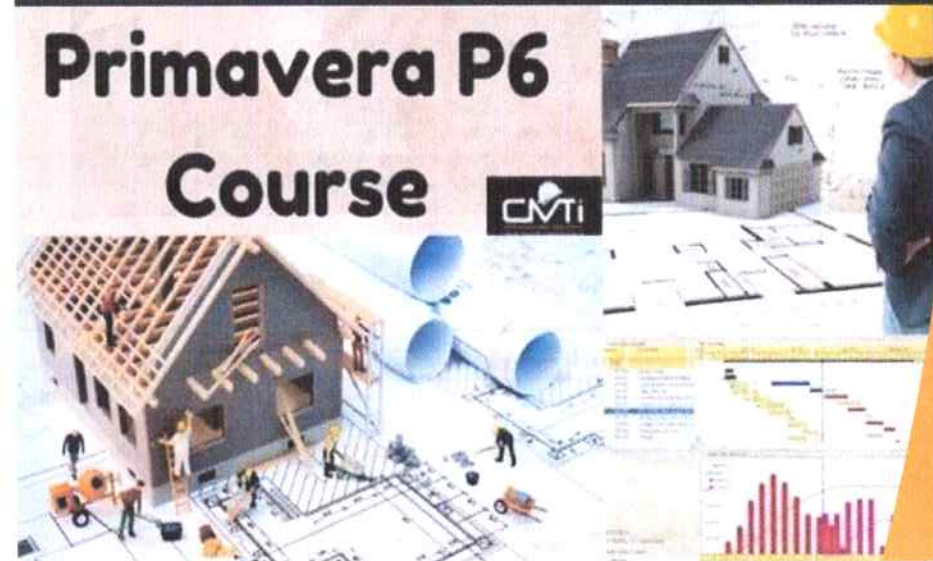



## About the Department

The Department of Civil Engineering in Sri Sivani College of Engineering was established in the year 2009 offering full time B. Tech (Civil). The Department has been advancing at a rapid pace with acquisition of advanced facilities, R&D, and dedicated teaching Faculty to properly motivate and mould the students for a better and prospective tomorrow. The strength of the department exists in the Physical Laboratories:

1. Surveying Field Work
2. Geotechnical Engg
3. Hydraulics
4. Strength of Materials
5. Concrete Technology
6. Environmental Engg
7. Engineering Geology
8. CAD / STAAD Pro



1. Mr. G. Raj Kumar  
M.Tech – Structural Engineering  
RVS Quality Certifications Pvt Ltd.  
rajkumarganta146@gmail.com  
9100361400

2. Mr. G. Sudharam Krishna  
M.Tech – Structural Engineering  
Assistant Professor  
Department of Civil Engineering  
SSCE, Chilakapalem  
sudharamsircivil@gmail.com  
7057435631

### RESOURCE PERSONS



## Topics to be Covered

- An overview of Project Schedule Management
- Fundamentals of Project Management
- What is a Project?
- What is Project Management?
  - Five Process Groups of Project Management
  - Schedule and its Importance
  - Critical Path Method for Scheduling
  - Understanding a Gantt chart
- Introduction to Primavera Systems & Oracle Primavera P6 PPM
- Primavera P6 Installation, Primavera P6 Interface and Preferences
- Organizational Breakdown Structure
- Enterprise Project Structure
- Work Breakdown Structure
- Planning your Work Schedule
- Understanding a Sample Project
- Creating a New Project in Primavera P6
- Project Window Options
- Understanding Project Must Finish and Total Float Roof
- Role of Calendars in Scheduling
- Understanding and Adding Calendars
- Project and Database Default Calendar
- Creating WBS in Primavera P6
- Understanding Percentage Complete Types
- Understanding Activity Types
- Setting Defaults for New Activities, Adding Activities
- Estimating Duration of Activities, Adding Duration of Activities
- Understanding Relationships
- Adding Relationships and Scheduling
- Understanding Scheduling Algorithm
- Scheduling Options
- Formatting Bars, Columns and Timescale, Group, Sorts & Layouts
- Filtering in Primavera P6
- Printing, Exporting and Importing
- Reporting in Primavera P6
- Understanding and Adding Baseline
- Updating a Project
- Assigning Baselines and Monitoring a Project
- Adding and Assigning New Currency
- Understanding Roles, Resources and Expenses, Adding Resources
- Duration Types in Primavera P6
- Assigning Resources and Reviewing Resource Allocation
- Adding Expenses
- Developing Project Funding Requirements and Cost S-curve
- Updating a Project with Resources and Expenses
- Question and Answers, Discussion on Final Reports

## REGISTRATION FORM

### A Two-Week Add-On Program

on

### “Construction Planning using Primavera P6”

Participant's Name: \_\_\_\_\_

Gender: Male/Female \_\_\_\_\_

Educational Qualifications: \_\_\_\_\_

Department: \_\_\_\_\_

Organization: \_\_\_\_\_

Address: \_\_\_\_\_

Phone No: \_\_\_\_\_

Signature of the Participant: \_\_\_\_\_





# SRI SIVANI COLLEGE OF ENGINEERING

(Under the Management of Sri Sivani Educational Society, Srikakulam)  
(Approved by AICTE, New Delhi and Affiliated to JNTUGV, Vizianagaram-CC-W6,  
UGC Recognition under 2(f) & 12(B), ISO 9001:2015 Certified)  
NH-16, Chilakapalem Jn., Srikakulam Dist. Andhra Pradesh -532410

## Department of Civil Engineering

Academic year: 2022-23

Date: 25-03-2023

Name of the program: A Two-Week Add-On Program on "Construction Planning using Primavera P6"

### List of Enrolled Students

S.No	Roll No	Name of the student	Year-Sem	Signature
1	19W61A0101	Bendi Sarath Chandra	IV-II	B. Sarath
2	19W61A0102	Biddika Krishna Babu	IV-II	B. Krishna
3	19W61A0104	Ch Lakshmi Prasad	IV-II	Ch. Lakshmi
4	19W61A0105	D Venkatasaikiran	IV-II	D. Venkatasaikiran
5	19W61A0106	Gudivada Eswararao	IV-II	G. Eswar
6	19W61A0107	Jarugulla Jai Kishore	IV-II	J. Jai Kishore
7	19W61A0108	K Koteswararao	IV-II	K. Koteswararao
8	19W61A0109	Kanchari Sai Kiran	IV-II	K. Sai Kiran
9	19W61A0110	Kevati Madhu	IV-II	K. Madhu
10	19W61A0111	K Bhavani Prasad	IV-II	K. Bhavani Prasad
11	19W61A0112	L Sunil Kumar	IV-II	L. Sunil Kumar
12	19W61A0113	M Murali Karthik	IV-II	M. Murali Karthik
13	19W61A0114	Nadiminti Kaladhar	IV-II	N. Kaladhar
14	19W61A0116	Paila Ashok Kumar	IV-II	P. Ashok Kumar
15	19W61A0117	Savara Durga Rao	IV-II	S. Durga Rao
16	19W61A0119	Savara Khagesh	IV-II	S. Khagesh
17	19W61A0121	Taddi Jagadeesh	IV-II	T. Jagadeesh
18	19W61A0122	Tangi Pavan Kumar	IV-II	T. Pavan Kumar
19	19W61A0123	Unkil Eswar Prasad	IV-II	U. Eswar Prasad
20	20W65A0101	A Shanmukha Srinivas	IV-II	A. Shanmukha Srinivas
21	20W65A0102	B Visweswara Reddy	IV-II	B. V. Reddy
22	20W65A0103	B Sai Sudhakar Sarma	IV-II	B. Sai Sudhakar Sarma
23	20W65A0104	Damodara Hema Sai	IV-II	D. Hema
24	20W65A0106	Kurmapu Karthika	IV-II	K. Karthika
25	20W65A0107	Kurmapu Karunya	IV-II	K. Karunya
26	20W65A0109	Vattam Suresh	IV-II	V. Suresh

P. Jagadeesh Rao  
Program Co-ordinator

Pavan  
Head of the Department





16	19W61A0119	Savara Khagesh	P	P	P	P	P	P	P	P	P	P
17	19W61A0121	Taddi Jagadeesh	P	P	P	P	P	P	P	P	P	P
18	19W61A0122	Tangi Pavan Kumar	P	P	P	P	P	AB	P	P	P	P
19	19W61A0123	Unkil Eswar Prasad	P	AB	P	P	P	AB	P	P	P	P
20	20W65A0101	A Shanmukha Srinivas	P	P	P	P	P	AB	P	P	P	P
21	20W65A0102	B Visweswara Reddy	P	P	P	P	P	P	P	P	P	P
22	20W65A0103	B Sai Sudhakar Sarma	P	P	P	P	P	P	P	P	P	P
23	20W65A0104	Damodara Hema Sai	P	P	P	P	P	P	P	P	P	P
24	20W65A0106	Kurmapu Karthika	P	P	P	P	P	P	P	P	P	P
25	20W65A0107	Kurmapu Karunya	P	P	P	P	P	P	P	P	P	P
26	20W65A0109	Vattam Suresh	P	P	P	P	P	P	P	P	P	P
Signature			PJS	PJS	PJS	PJS	PJS	PJS	PJS	PJS	PJS	PJS

  
**Program Co-ordinator**





# SRI SIVANI COLLEGE OF ENGINEERING

(Under the Management of Sri Sivani Educational Society, Srikakulam)  
(Approved by AICTE, New Delhi and Affiliated to JNTUGV, Vizianagaram-CC-W6,  
UGC Recognition under 2(f) & 12(B), ISO 9001:2015 Certified)  
NH-16, Chilakapalem Jn., Srikakulam Dist. Andhra Pradesh -532410

## Department of Civil Engineering

Academic year: 2022-23

Date: 08-04-2023

### PROGRAM REPORT

- **Name of the program:** A Two-Week Add-On Program on “Construction Planning using Primavera P6”
- **Date:** 27-03-2023 to 06-04-2023
- **Name of the Resource Persons:**
  1. Mr. G. Raj Kumar  
M.Tech – Structural Engineering  
RVS Quality Certifications Pvt Ltd.  
[rajkumarganta146@gmail.com](mailto:rajkumarganta146@gmail.com)  
9100361400
  2. Mr. G. Sudharam Krishna  
M.Tech – Structural Engineering  
Assistant Professor  
Department of Civil Engineering  
SSCE, Chilakapalem  
[sudharamsircivil@gmail.com](mailto:sudharamsircivil@gmail.com)  
7057435631
- **Details of the Program Coordinator:** P Jagadeeshwara Rao  
M.Tech – Structural Engineering  
Asst. Professor  
Department of Civil Engineering  
SSCE, Chilakapalem  
[Jagadeeshrao266@gmail.com](mailto:Jagadeeshrao266@gmail.com)  
8179048756

- **Objectives of the program:**

- ✓ **Timelines:** A bar graph using a classic Gantt chart to schedule jobs is within your access.
- ✓ **Risk management:** You can recognize, monitor, and address hazards before they materialize.
- ✓ **Informative dashboard:** A dashboard for monitoring important project parameters is provided.
- ✓ **Reporting and analytics:** This software has the optimal arrangement to produce status reports for stakeholders.
- ✓ **Resource Analysis & Allocation:** It monitors resources and adjusts allocations as necessary.
- ✓ **Schedule & Activities Views:** You can examine project tasks overlaid on a calendar.
- ✓ **Contract Managing:** Multiple projects can be managed simultaneously in a program or portfolio using portfolio and program management.
- ✓ **Scheduling alerts:** You can keep the project on schedule by constantly being aware of what is due and when.

- **Topics Covered**

- An overview of Project Schedule Management
- Fundamentals of Project Management
- What is a Project?
- What is Project Management?
  - Five Process Groups of Project Management
  - Schedule and its Importance
  - Critical Path Method for Scheduling
  - Understanding a Gantt chart
- Introduction to Primavera Systems and Oracle Primavera P6 PPM
- Primavera P6 Installation
- Primavera P6 Interface and Preferences
- Organizational Breakdown Structure
- Enterprise Project Structure
- Work Breakdown Structure
- Planning your Work Schedule
- Understanding a Sample Project
- Creating a New Project in Primavera P6
- Project Window Options
- Understanding Project Must Finish and Total Float Roof
- Role of Calendars in Scheduling
- Understanding and Adding Calendars
- Project and Database Default Calendar
- Creating WBS in Primavera P6
  - Understanding Percentage Complete Types
- Understanding Activity Types
- Setting Defaults for New Activities



- Adding Activities
- Estimating Duration of Activities
- Adding Duration of Activities
- Understanding Relationships
- Adding Relationships and Scheduling
- Understanding Scheduling Algorithm
- Scheduling Options
- Formatting Bars, Columns and Timescale
- Group, Sorts and Layouts
- Filtering in Primavera P6
- Printing, Exporting and Importing
- Reporting in Primavera P6
- Understanding and Adding Baseline
- Updating a Project
- Assigning Baselines and Monitoring a Project
- Adding and Assigning New Currency
- Understanding Roles, Resources and Expenses
- Adding Resources
- Duration Types in Primavera P6
- Assigning Resources and Reviewing Resource Allocation
- Adding Expenses
- Developing Project Funding Requirements and Cost S-curve
- Updating a Project with Resources and Expenses
- Question and Answers
- Discussion on Final Reports



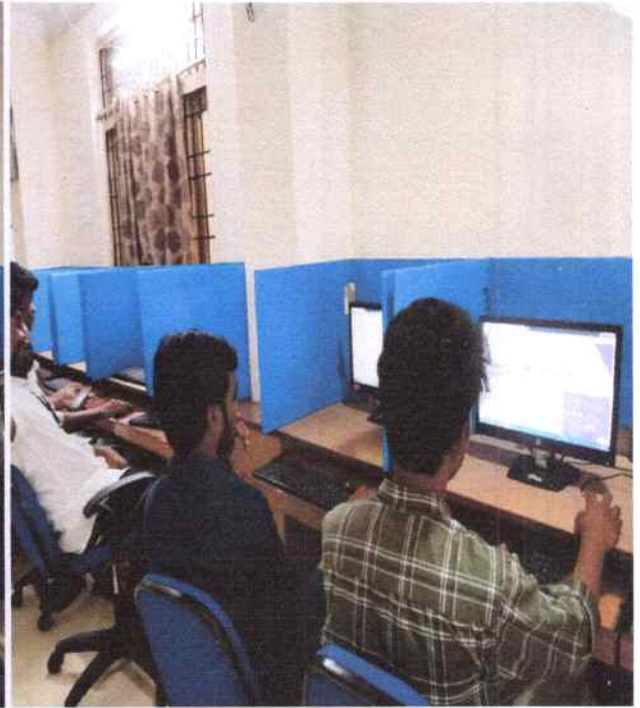
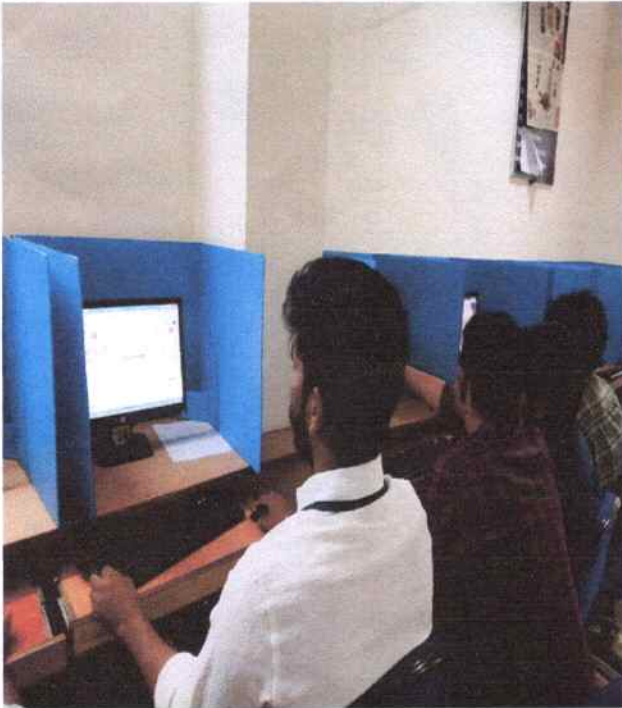



- **Outcomes of the Program: On completion of this program, student can:**

- ✓ Ability to create and manage project enterprise structure within Primavera P6 database.
- ✓ Create project work breakdown structure.
- ✓ Develop resource loaded or simple project schedule.
- ✓ Manage the project time frame related constraints.

- **Number of participants: 26**

*P. Jagadeeshwar Rao*  
**Program Co-ordinator**

*Paran*  
**Head of the Department**



# SRI SIVANI COLLEGE OF ENGINEERING

(Under the Management of Sri Sivani Educational Society, Srikakulam)  
(Approved by AICTE, New Delhi and Affiliated to JNTUGV, Vizianagaram-CC-W6,  
UGC Recognition under 2(f) & 12(B), ISO 9001:2015 Certified)  
NH-16, Chilakapalem Jn., Srikakulam Dist. Andhra Pradesh -532410

## CERTIFICATE OF PARTICIPATION

This is to certify that Mr./Ms. Kanchasi Sai Kiran bearing  
Roll No 19W61A0109 of IV<sup>th</sup> Year II<sup>nd</sup> Semester has completed  
A Two-Week Add-On Program on "Construction planning using Primavera P6" during the  
period 27-03-2023 to 06-04-2023 organized by Department of Civil Engineering.

*P. Jagadishwar Rao*  
Co-Ordinator

*Palas*  
HOD

*J. Srinivas Rao*  
Principal





# SRI SIVANI COLLEGE OF ENGINEERING

(Under the Management of Sri Sivani Educational Society, Srikakulam)  
(Approved by AICTE, New Delhi and Affiliated to JNTUGV, Vizianagaram-CC-W6,  
UGC Recognition under 2(f) & 12(B), ISO 9001:2015 Certified)  
NH-16, Chilakapalem Jn., Srikakulam Dist. Andhra Pradesh -532410

## CERTIFICATE OF PARTICIPATION

This is to certify that Mr./Ms. Savara Duriga Rao bearing  
Roll No 19W61A0117 of IV<sup>th</sup> Year II<sup>nd</sup> Semester has completed  
A Two-Week Add-On Program on "Construction planning using Primavera P6" during the  
period 27-03-2023 to 06-04-2023 organized by Department of Civil Engineering.

*P. Jagadeeshwar Rao*  
Co-Ordinator

*Palan*  
HOD

*S. Sivani*  
Principal



# SRI SIVANI COLLEGE OF ENGINEERING

(Under the Management of Sri Sivani Educational Society, Srikakulam)  
(Approved by AICTE, New Delhi and Affiliated to JNTUGV, Vizianagaram-CC-W6,  
UGC Recognition under 2(f) & 12(B), ISO 9001:2015 Certified)  
NH-16, Chilakapalem Jn., Srikakulam Dist. Andhra Pradesh -532410

## CERTIFICATE OF PARTICIPATION

This is to certify that Mr./Ms. Kurmapu Karthika bearing  
Roll No 20W65A0106 of IV<sup>th</sup> Year II<sup>nd</sup> Semester has completed  
A Two-Week Add-On Program on "Construction planning using Primavera P6" during the  
period 27-03-2023 to 06-04-2023 organized by Department of Civil Engineering.

*P. Jagadishwar Reddy*  
Co-Ordinator

*Paras*  
HOD

*V. Srinivasulu*  
Principal





# SRI SIVANI COLLEGE OF ENGINEERING

(Under the Management of Sri Sivani Educational Society, Srikakulam)  
(Approved by AICTE, New Delhi and Affiliated to JNTUGV, Vizianagaram-CC-W6,  
UGC Recognition under 2(f) & 12(B), ISO 9001:2015 Certified)  
NH-16, Chilakapalem Jn., Srikakulam Dist. Andhra Pradesh -532410

Date: 17-03-2023







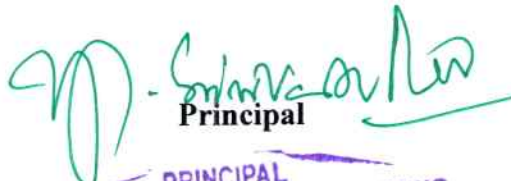



## CIRCULAR

This is to inform that the Department of Computer Science and Engineering is organizing “A Two-Week Add-On Program on “Game Design Using Unity 3-D” during 27-03-2023 to 06-04-2023 to the second year CSE students to enhance their programming knowledge applicable for job opportunities. The goal of the “Game Design Using Unity 3D” Provides skills and graphic design competencies in software required for effective work practices in this sector. In this regard, I suggest all the second year CSE students to enroll this course without fail on before 24-03-2023.

**Venue:** Block -1, CP LAB-1, SSCE  
**Co-ordinator:** Mrs. K.Sakunthala, Asst. Prof,  
Department of Computer Science and Engineering

  
Principal  
PRINCIPAL  
SRI SIVANI COLLEGE OF ENGINEERING  
Chilakapalem Jn., SRIKAKULAM

### Copy to

Dept.	IQAC	CIVIL	EEE	MECH	ECE	CSE	H&BS	MBA	TPO	Office	Library
Signature											

CC To: The Management: for information.



# SRI SIVANI COLLEGE OF ENGINEERING

(Under the Management of Sri Sivani Educational Society, Srikakulam)  
(Approved by AICTE, New Delhi and Affiliated to JNTUGV, Vizianagaram-CC-W6,  
UGC Recognition under 2(f) & 12(B), ISO 9001:2015 Certified)  
NH-16, Chilakapalem Jn., Srikakulam Dist. Andhra Pradesh -532410

## Department of Computer Science & Engineering

Academic Year: 2022-23

Date: 17-03-2023

Name of the program: A Two-Week Add-On Program on "Game Design Using Unity 3D"

### PROGRAMME SCHEDULE

S.NO.	DATE	Topics To Be Covered
1	27/03/2023	Downloading Unity and Unity Hub
2	28/03/2023	About Unity Versions and Creating a New Project
3	29/03/2023	Introduction to Unity's Interface
4	31/03/2023	Starting with Unity's Basics
5	01/04/2023	Audio Source and Ui Elements
6	02/04/2023	Moving Our Character with Code
7	03/04/2023	Introduction to Variables
8	04/04/2023	Operations with Variables
9	05/04/2023	Functions, Conditional Statements
10	06/04/2023	Loops, Coroutines, Classes, Inheritance

  
Program Co-ordinator

  
Head of the Department



## ABOUT THE INSTITUTION

Sri Sivani College of Engineering (SSCE) is one of the colleges functioning under Sri Sivani Educational Society, established in 2006 affiliated to JNTUGV, Vizianagaram-CC-W6 UGC Recognition under 2(f) & 12(B). ISO 9001:2015 Certified. SSCE is situated in a spacious 12 acres campus adjacent to NH-16 at Chilakapalem, Srikakulam, Andhra Pradesh. SSCE offers B. Tech programs in Civil, C.S.E, E.E.E, E.C.E, Mechanical Engineering and PG programmes M.B.A, M.Tech and Diploma programmes for Civil, E.E.E and Mechanical Engineering. Fully connected through Fiber Optics and Wi-Fi Networks, Endowed .

## ABOUT THE DEPARTMENT

The Department of Computer Science & Engineering of Sri Sivani College of Engineering was established in the year 2006 and playing a vital role in designing, developing maintaining software and hardware for the entire college. It has been offering full time B. Tech (CSE), M.Tech (CSE) courses.

The Department has been advancing at a rapid pace with the acquisition of advanced facilities and dedicated teaching faculty to properly motivate and mould the students for a better and prospective tomorrow. The Department is adequately equipped with several full fledged computer laboratories and research groups in order to enhance R & D and consult.

## SRI SIVANI COLLEGE OF ENGINEERING

Under the Management of Sri Sivani Educational Society, Srikakulam) (Approved by AICTE, New Delhi and Affiliated to JNTUGV, Vizianagaram-CC-W6, UGC Recognition under 2(f) & 12(B), ISO 9001:2015 Certified) NH-16, Chilakapalem Jn., Srikakulam Dist. Andhra Pradesh -532410

### PATRONS

Sri.V.M.M.Sainadh Reddy

*President*

Sri.J. Suryachandra Rao

*Vice President*

Sri. K. Durga Srinivas

*Secretary*

Sri. D. Venkata Rao

*Treasurer*

Sri. P. Durga Prasad Raju

*Joint Secretary*

Dr. S. Srinivasa Rao

*Correspondent*

### Chairman

Dr. Y. Srinivasa Rao

*Principal, SSCE.*

*Convener*

M. Murali Krishna

*H.O.D, Dept of CSE*

*Co-ordinator*

Mrs. K. Sakunthala M.tech

*Assistant Professor*

*CSE Department*



**A TWO-WEEK ADD-ON PROGRAM ON  
"GAME DESIGN USING UNITY 3D"**

**(27-03-2023 TO 06-04-2023)**

*Organized by*  
**Department of Computer Science &  
Engineering**





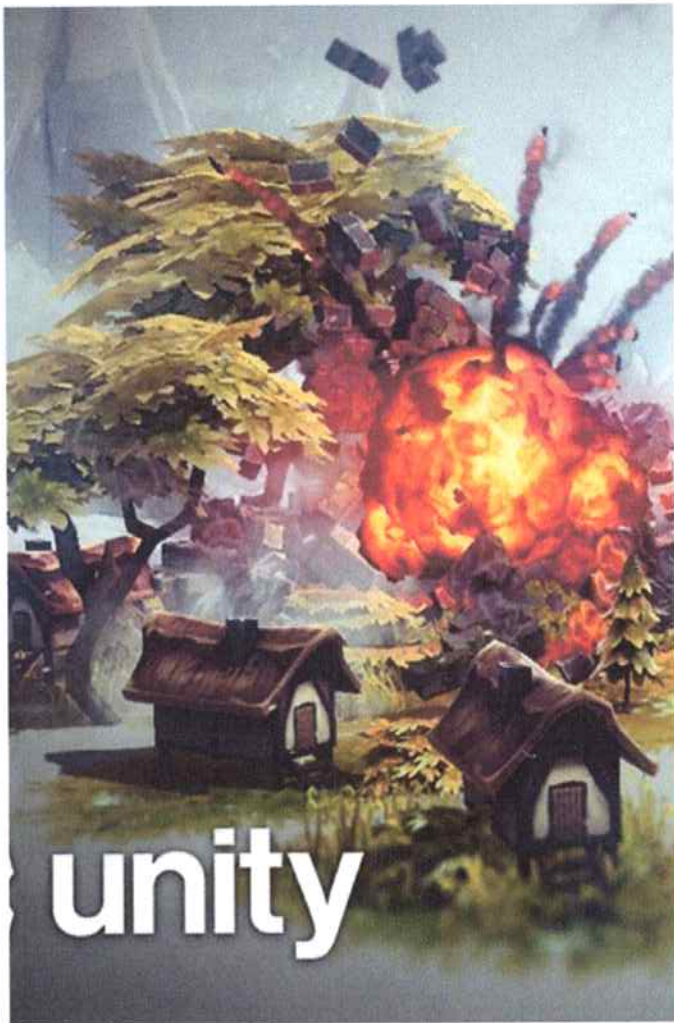

## PROGRAM CONTENT:

- Downloading Unity and Unity Hub
- About Unity Versions and Creating a New Project
- Introduction to Unity's Interface
- Starting with Unity's Basics
- Audio Source and Ui Elements
- Moving Our Character with Code
- Introduction to Variables
- Operations with Variables
- Functions, Conditional Statements
- Loops, Coroutines, Classes, Inheritance



## REGISTRATION FORM

### A Two-Week Add-On Program on "Game Design Using Unity 3D"

( 27-03-2023 to 06-04-2023)

Participant's Name:

Gender: Male/ Female

Educational Qualifications:

Department:

Organization:

Address for Communication:

Email:

Phone No:

Date:

Signature of the Participant

### Objectives of the program:

- Cross-Platform Compatibility: One of the biggest advantages of Unity is its unparalleled cross platform compatibility.
- Robust Intuitive Development Environment.
- Powerful Performance Optimization.
- Active Community and support.





# SRI SIVANI COLLEGE OF ENGINEERING

(Under the Management of Sri Sivani Educational Society, Srikakulam)  
(Approved by AICTE, New Delhi and Affiliated to JNTUGV, Vizianagaram-CC-W6,  
UGC Recognition under 2(f) & 12(B), ISO 9001:2015 Certified)  
NH-16, Chilakapalem Jn., Srikakulam Dist. Andhra Pradesh -532410

## Department of Computer Science & Engineering

Academic Year: 2022-23

Date: 27-03-2023

Name of the program: A Two-Week Add-On Program on "Game Design Using Unity 3D"

### List of Enrolled Students

S.No	Roll No	Name Of The Student	Year-Sem	Signature
1	21W61A0501	Aggala Krishna	II-II	A. Krishna
2	21W61A0502	Ambati Hari	II-II	A. Hari
3	21W61A0503	Ambugam Premkumar	II-II	A. Premkumar
4	21W61A0504	Ampolu Hemalatha	II-II	A. Hemalatha
5	21W61A0505	Anapu Yamuna	II-II	A. Yamuna
6	21W61A0506	Bagadi Santhosh Kumar	II-II	B. Santhosh Kumar
7	21W61A0507	Balivada D S Venkata Lakshmi	II-II	B. D. S. Venkata Lakshmi
8	21W61A0508	Bankuru Sneha Priya	II-II	B. Sneha Priya
9	21W61A0509	Bendi Likhitha	II-II	B. Likhitha
10	21W61A0510	Biddika Eliya Kumar	II-II	B. Eliya Kumar
11	21W61A0511	Bonela Bhavana	II-II	B. Bhavana
12	21W61A0512	Boyina Kalyani	II-II	B. Kalyani
13	21W61A0513	Buragapu Abhishek	II-II	B. Abhishek
14	21W61A0514	Chigilipalli Swathi	II-II	Ch. Swathi
15	21W61A0515	Chintada Siresha	II-II	Ch. Siresha
16	21W61A0516	Chodipalli Sagar	II-II	Ch. Sagar
17	21W61A0517	Dharmavarap U Devisrilekha	II-II	D. U. Devisrilekha
18	21W61A0518	Duba Chiranjeevi	II-II	D. Chiranjeevi
19	21W61A0519	Dunga Mahendra	II-II	D. Mahendra
20	21W61A0520	Edubilli Kalyan Kumar	II-II	E. Kalyan Kumar
21	21W61A0521	Gangarapu Karthik	II-II	G. Karthik

22	21W61A0522	Ginni Rajyalakshmi	II-II	G. Rajyalakshmi
23	21W61A0523	Goddu Pujitha	II-II	G. Pujitha
24	21W61A0524	Gorle Manikanta	II-II	G. Manikanta
25	21W61A0525	Gunta Abhinaya	II-II	G. Abhinaya
26	21W61A0526	Gurugubelli Priyanka	II-II	G. Priyanka
27	21W61A0527	Kadiri Kusuma	II-II	K. Kusuma
28	21W61A0528	Kandula Prem Sagar	II-II	K. Prem Sagar
29	21W61A0529	Karanam Akhileswari	II-II	K. Akhileswari
30	21W61A0530	Karanam Madhumitha	II-II	K. Madhumitha
31	21W61A0531	Karanam Santosh	II-II	K. Santosh
32	21W61A0532	Karnayana Sai Prasanna	II-II	K. Sai Prasanna
33	21W61A0533	Karri Gurumurthy	II-II	K. Gurumurthy
34	21W61A0534	Karubothu Tejaswi	II-II	K. Tejaswi
35	21W61A0535	Kesireddy Abhinav	II-II	K. Abhinav
36	21W61A0536	Kesireddy Abhiram	II-II	K. Abhiram
37	21W61A0537	Killamsetty Vivek	II-II	K. Vivek
38	21W61A0538	Komara Alekhya	II-II	K. Alekhya
39	21W61A0539	Konada Swathi	II-II	K. Swathi
40	21W61A0540	Kondapalli Lakshman	II-II	K. Lakshman
41	21W61A0541	Korukonda Bhanu Teja	II-II	K. Bhanu Teja
42	21W61A0542	Kuruhuru Hema Sunder Babu	II-II	K. Hema Sunder Babu
43	21W61A0543	Laveti Divya	II-II	L. Divya
44	21W61A0544	Likhitha Routhu	II-II	L. Routhu
45	21W61A0545	Lotla Gowthami	II-II	L. Gowthami
46	21W61A0546	Lukalapu Gayatri	II-II	L. Gayatri
47	21W61A0547	Maddi Kavya	II-II	M. Kavya
48	21W61A0548	Menda Yugandhar	II-II	M. Yugandhar
49	21W61A0549	Muddapu Krishna Vamsee	II-II	M. Krishna Vamsee
50	21W61A0550	Mukalla Kovida	II-II	M. Kovida
51	21W61A0551	Mundurur Gowthami	II-II	M. Gowthami
52	21W61A0552	Muravadala Jyothi	II-II	M. Jyothi
53	21W61A0553	Najana Durgaprasad	II-II	N. Durgaprasad



54	21W61A0554	Nemana Venkata Jagannadha <del>Chandrabhaga</del>	II-II	No Venkata Jagannadha
55	21W61A0555	P Ramesh	II-II	P. Ramesh
56	21W61A0556	Paila Rupasankar	II-II	P. Rupasankar
57	21W61A0557	Palasa Jagadeesh	II-II	P. Jagadeesh
58	21W61A0558	Palli Dharani	II-II	P. Dharani
59	21W61A0559	Pandiri Jayasri	II-II	P. Jayasri
60	21W61A0560	Panduru Raghu	II-II	P. Raghu
61	21W61A0561	Patruni Jyothsna	II-II	P. Jyothsna
62	21W61A0562	Pavan Sai Kuppannagari	II-II	K. Pavan Sai
63	21W61A0563	Pedada Revanth Kumar	II-II	P. Revanth Kumar
64	21W61A0564	Peddakota Lalitha	II-II	P. Lalitha
65	21W61A0565	Pekala Surya	II-II	P. Surya
66	21W61A0566	Penta Sai Kiran	II-II	P. Sai Kiran
67	21W61A0567	Pilli Pavani	II-II	P. Pavani
68	21W61A0568	Pinninti Vasantha	II-II	P. vasantha
69	21W61A0569	Pinninti Vikas	II-II	P. vikas
70	21W61A0570	Pogaru Siva Sivani	II-II	P. Siva Sivani
71	21W61A0571	Pothula Anjali	II-II	P. Anjali
72	21W61A0572	Priya Asritha	II-II	P. Asritha
73	21W61A0573	Puligopu Sai Surya Gurucharan	II-II	P. Saisurya Gurucharan
74	21W61A0574	Raghupatruni Pravallika	II-II	P. Pravallika
75	21W61A0575	Runku Jyothirmayi	II-II	R. Jyothirmayi
76	21W61A0576	Sathyavarapu Akash	II-II	S. Akash
77	21W61A0577	Savadala Venkata Ramana	II-II	S. Venkata Ramana
78	21W61A0578	Seerapu Navya	II-II	S. Navya
79	21W61A0579	Sigalapelli Hemanth	II-II	S. Hemanth
80	21W61A0580	Srikakulam Neelima	II-II	S. Neelima
81	21W61A0581	Surabattula Sai Ganitha	II-II	S. Sai Ganitha
82	21W61A0582	Talasu Sai Manikanta	II-II	T. Sai Manikanta
83	21W61A0583	Tankala Hemanth Kumar	II-II	T. Hemanth Kumar
84	21W61A0584	Tankala Mallikharjuna Rao	II-II	T. Mallikharjuna Rao
85	21W61A0585	Thogarapu Syamala	II-II	T. syamala

86	21W61A0586	Tulagapu Pradeep Kumar	II-II	T. Pradeep Kumar
87	21W61A0587	Udandarao Siri Bhavana	II-II	U. Siri Bhavana
88	21W61A0588	Undralla Narayana Murthy	II-II	U. Narayana Murthy
89	21W61A0589	Vakada Durga Prasad	II-II	V. Durga Prasad
90	21W61A0590	Varanasi Bhavanishan Kar	II-II	V. Bhavanishan Kar
91	21W61A0591	Yagoti Dileep	II-II	Y. Dileep
92	21W61A0592	Yerra Kavya	II-II	Y. Kavya

  
Program Co-ordinator

  
Head of the Department











77	21W61A0577	SavadalaVenkataRamana	P	P	P	P	P	P	P	P	P	P
78	21W61A0578	SeerapuNavya	P	P	P	P	P	P	P	P	P	P
79	21W61A0579	SigalapelliHemanth	P	P	P	P	P	P	P	P	P	P
80	21W61A0580	Srikakulam Neelima	P	P	P	P	P	P	P	P	P	P
81	21W61A0581	Surabattula Sai Ganitha	P	P	P	P	P	P	P	P	P	AB
82	21W61A0582	Talasu Sai Manikanta	AB	P	P	P	P	P	P	P	P	P
83	21W61A0583	TankalaHemanth Kumar	P	P	P	P	P	P	P	P	P	P
84	21W61A0584	TankalaMallikharjuna Rao	P	P	P	P	P	P	P	P	P	P
85	21W61A0585	ThogarapuSyamala	P	P	P	P	P	P	P	P	P	P
86	21W61A0586	Tulagapu Pradeep Kumar	P	P	P	P	P	P	AB	P	P	P
87	21W61A0587	Udandarao Siri Bhavana	P	P	P	P	P	P	P	P	P	P
88	21W61A0588	Undralla Narayana Murthy	P	P	P	P	P	P	P	P	P	P
89	21W61A0589	VakadaDurga Prasad	P	P	P	P	P	P	P	P	P	P
90	21W61A0590	Varanasi BhavanishanKar	P	P	P	AB	P	P	P	P	P	P
91	21W61A0591	YagotiDileep	P	P	P	P	P	P	P	P	P	P
92	21W61A0592	YerraKavya	P	P	P	P	P	P	P	P	P	P
<b>Signature</b>												

  
Program Co-ordinator



# SRI SIVANI COLLEGE OF ENGINEERING

(Under the Management of Sri Sivani Educational Society, Srikakulam)  
(Approved by AICTE, New Delhi and Affiliated to JNTUGV, Vizianagaram-CC-W6,  
UGC Recognition under 2(f) & 12(B), ISO 9001:2015 Certified)  
NH-16, Chilakapalem Jn., Srikakulam Dist. Andhra Pradesh -532410

## Department of Computer Science & Engineering

Academic year: 2022-2023

Date: 10-04-2023

### PROGRAM REPORT

**Name of the Program:** A Two-Week Add-On Program on “Game Design Using Unity 3D”

**Program Duration:** 27-03-2023 to 06-04-2023

**Details of the Resource Person:** Mr. N. Sai Kiran, M. Tech  
Assistant Professor  
Dept. of C.S.E.  
[mohan.saikiran@gmail.com](mailto:mohan.saikiran@gmail.com)  
9346259619

**Details of the Program coordinator:** Mrs. K. Sakunthala, M. Tech,  
Assistant Professor  
Dept. of C.S.E.  
[jhansi.b519@gmail.com](mailto:jhansi.b519@gmail.com)  
7337218626

#### **Objectives of the program:**

- Cross-Platform Compatibility: One of the biggest advantages of Unity is its unparalleled cross-platform compatibility.
- Robust and Intuitive Development Environment.
- Powerful Performance Optimization.
- Active Community and Support.

#### **Topics covered:**

- Downloading Unity and Unity Hub
- About Unity Versions and Creating a New Project
- Introduction to Unity's Interface
- Starting with Unity's Basics
- Audio Source and Ui Elements
- Moving Our Character with Code



- Introduction to Variables
- Operations with Variables
- Functions, Conditional Statements
- Loops, Coroutines, Classes, Inheritance
- Accessibility Modifiers(Data Encapsulation)



**Outcome of the program:**

- This heightened sense of immersion enhances the overall gaming experience.
- 3D games offer a higher level of realism and immersion by simulating three-dimensional spaces, enabling players to explore lifelike environments and characters.
- 3D design refers to using software to create a digital model of a three-dimensional shape or object.
- Organizations and professionals across industries use 3D design to communicate ideas, create products and customer experiences, teach concepts, and more.

**Number of Participants: 92**

  
**Program Co-ordinator**





# SRI SIVANI COLLEGE OF ENGINEERING

(Under the Management of Sri Sivani Educational Society, Srikakulam)

(Approved by AICTE, New Delhi and Affiliated to JNTUGV, Vizianagaram-CC-W6,

UGC Recognition under 2(f) & 12(B), ISO 9001:2015 Certified)

NH-16, Chilakapalem Jn., Srikakulam Dist. Andhra Pradesh -532410

## CERTIFICATE OF PARTICIPATION

This is to certify that Mr./Ms. Aggala Krishna bearing  
Roll No 21W61A0501 of 2<sup>nd</sup> Year II Semester has completed A Two-  
Week Add-On Program on "Game Design Using Unity 3D" during the period 27-03-2023 to  
06-04-2023 organized by Department of Computer Science Engineering.

  
Co-ordinator

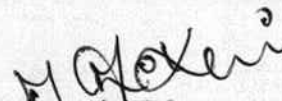
  
HOD

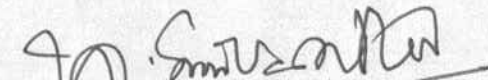
  
Principal



# SRI SIVANI COLLEGE OF ENGINEERING

(Under the Management of Sri Sivani Educational Society, Srikakulam)  
(Approved by AICTE, New Delhi and Affiliated to JNTUGV, Vizianagaram-CC-W6,  
UGC Recognition under 2(f) & 12(B), ISO 9001:2015 Certified)  
NH-16, Chilakapalem Jn., Srikakulam Dist. Andhra Pradesh -532410

## CERTIFICATE OF PARTICIPATION

This is to certify that Mr./Ms. Bonela Bhavana bearing  
Roll No 21W6/A0511 of 2<sup>nd</sup> Year II Semester has completed A Two-  
Week Add-On Program on "Game Design Using Unity 3D" during the period 27-03-2023 to  
06-04-2023 organized by Department of Computer Science Engineering.

  
Co-ordinator

  
HOD

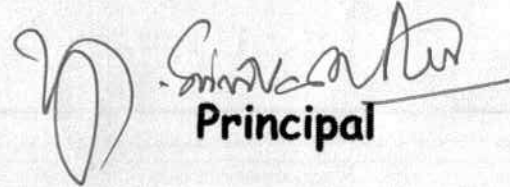
  
Principal





# SRI SIVANI COLLEGE OF ENGINEERING

(Under the Management of Sri Sivani Educational Society, Srikakulam)  
(Approved by AICTE, New Delhi and Affiliated to JNTUGV, Vizianagaram-CC-W6,  
UGC Recognition under 2(f) & 12(B), ISO 9001:2015 Certified)  
NH-16, Chilakapalem Jn., Srikakulam Dist. Andhra Pradesh -532410

## CERTIFICATE OF PARTICIPATION

This is to certify that Mr./Ms. Dunga Mahendra bearing  
Roll No 21W61A0519 of 2<sup>nd</sup> Year II Semester has completed A Two-  
Week Add-On Program on "Game Design Using Unity 3D" during the period 27-03-2023 to  
06-04-2023 organized by Department of Computer Science Engineering.

  
Co-ordinator

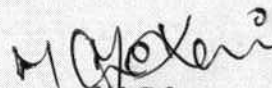
  
HOD

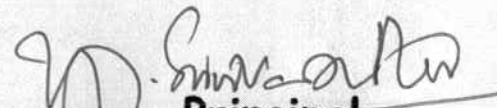
  
Principal



# SRI SIVANI COLLEGE OF ENGINEERING

(Under the Management of Sri Sivani Educational Society, Srikakulam)  
(Approved by AICTE, New Delhi and Affiliated to JNTUGV, Vizianagaram-CC-W6,  
UGC Recognition under 2(f) & 12(B), ISO 9001:2015 Certified)  
NH-16, Chilakapalem Jn., Srikakulam Dist. Andhra Pradesh -532410

## CERTIFICATE OF PARTICIPATION

This is to certify that Mr./Ms. Bendi Likhitha bearing  
Roll No 210261A0509 of 2<sup>nd</sup> Year B Semester has completed A Two-  
Week Add-On Program on "Game Design Using Unity 3D" during the period 27-03-2023 to  
06-04-2023 organized by Department of Computer Science Engineering.

  
Co-ordinator

  
HOD

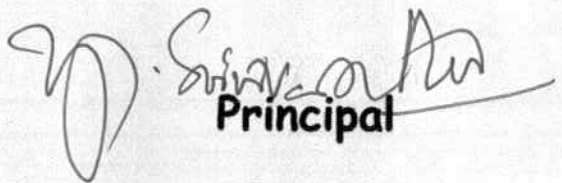
  
Principal





# SRI SIVANI COLLEGE OF ENGINEERING

(Under the Management of Sri Sivani Educational Society, Srikakulam)  
(Approved by AICTE, New Delhi and Affiliated to JNTUGV, Vizianagaram-CC-W6,  
UGC Recognition under 2(f) & 12(B), ISO 9001:2015 Certified)  
NH-16, Chilakapalem Jn., Srikakulam Dist. Andhra Pradesh -532410

## CERTIFICATE OF PARTICIPATION

This is to certify that Mr./Ms. Chodipalli Sagar bearing  
Roll No 21W61A0516 of 2<sup>nd</sup> Year II Semester has completed A Two-  
Week Add-On Program on "Game Design Using Unity 3D" during the period 27-03-2023 to  
06-04-2023 organized by Department of Computer Science Engineering.

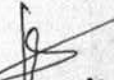
  
Co-ordinator

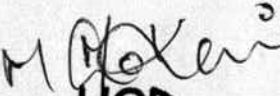
  
HOD

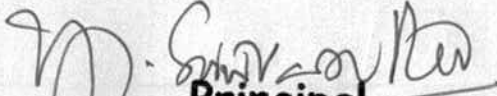
  
Principal



# SRI SIVANI COLLEGE OF ENGINEERING

(Under the Management of Sri Sivani Educational Society, Srikakulam)  
(Approved by AICTE, New Delhi and Affiliated to JNTUGV, Vizianagaram-CC-W6,  
UGC Recognition under 2(f) & 12(B), ISO 9001:2015 Certified)  
NH-16, Chilakapalem Jn., SrikakulamDist -532410

Date: 28-03-2023

## CIRCULAR

This is to inform that the Department of Mechanical Engineering is organizing A Two Week Add-on Program on “4<sup>th</sup> industrial revolution using Industry 4.0” from 3/4/2023 to 15/4/2023. This program allows learners to explore the Fundamentals of Industry 4.0, Industry 4.0 in Manufacturing, Data-Driven Decision Making, Supply Chain Resilience. In this regard, I suggest all 3<sup>rd</sup> and 4<sup>th</sup> year mechanical students to enroll this course on or before 3/04/2023.







**Venue:** Seminar hall, Block-1

**Coordinator:** Mr. V. Ravi Teja, Asst. Professor

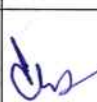
Dept. of Mechanical Engineering

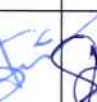
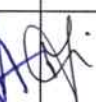
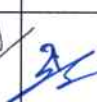
  
Principal  
PRINCIPAL  
SRI SIVANI COLLEGE OF ENGINEERING  
Chilakapalem Jn., SRIKAKULAM

**Copy to**

Dept.	IQAC	Civil	EEE	Mech	ECE	CSE	H&BS	MBA	TPO	Office	Library
Signature											

CC To: The Management: for information.





# SRI SIVANI COLLEGE OF ENGINEERING

(Under the Management of Sri Sivani Educational Society, Srikakulam)  
(Approved by AICTE, New Delhi and Affiliated to JNTUGV, Vizianagaram-CC-W6,  
UGC Recognition under 2(f) & 12(B), ISO 9001:2015 Certified)  
NH-16, Chilakapalem Jn., SrikakulamDist -532410

## Department of Mechanical Engineering

Academic Year: 2022 – 2023

Date: 3/04/2023

### PROGRAM SCHEDULE

Name of the Program: A Two Week Add-on Program on “4<sup>th</sup> industrial revolution using Industry 4.0”

S.NO	DATE	Topics to be covered
01	3/4/2023	Introduction to Industry 4.0
02	4/4/2023	Automation and Robotics
03	5/4/2023	Internet of Things (IoT)
04	6/4/2023	IoT in Supply Chain Resilience
05	8/4/2023	Smart Factories and Digital Twins
06	9/4/2023	Data Analytics and AI
07	10/4/2023	Artificial Intelligence Applications
08	11/4/2023	Building Resilient Supply Chains
09	12/4/2023	Post-Pandemic Supply Chain Management
10	13/4/2023	Post-Pandemic Case Studies
11	15/4/2023	Best Practices in Post-Corona Adaptations

V. Ravi Teja.  
Program Coordinator

  
Head of the Department

## ABOUT THE INSTITUTION

Sri Sivani College of Engineering (SSCE) is one of the colleges functioning under Sri Sivani Educational Society, established in 2006 affiliated to JNTUGV, Vizianagaram. UGC Recognition under 2(f) & 12(B). ISO 9001:2015 Certified. SSCE is situated in a spacious 12 acres campus adjacent to NH-16 at Chilakapalem, Srikakulam, Andhra Pradesh.

SSCE offers B. Tech programs in Civil, C.S.E, E.E.E, E.C.E, Mechanical Engineering and PG programmes M.B.A. M.Tech and Diploma programmes for Civil, E.E.E and Mechanical Engineering. Fully connected through Fiber Optics and Wi-Fi Networks. Endowed with fully Qualified, well experienced and seasoned faculty members equipped with industrial experience and fully established laboratories with state-of-the-art technologies meets the growing needs of the students.

## ABOUT THE DEPARTMENT

SSCE started Mechanical Engineering programme in 2009. The Faculty in the department are in the track of excellence in terms of qualification and experience. Coming from various reputed universities, industries and research oriented organizations, faculty are committed to the noble cause of teaching learning process synchronizing with their efforts. It gives facilities to train in analytical, simulation, design and development and experimental techniques in the Capstone Project. Our department students are developing good research skills, technical and managerial skills which help them to become good technocrats in the society. The laboratories under various domains are fully equipped with up to date experimental facilities and machineries to train our students and to conduct research. Its got trained in Solid Edge design laboratory, AutoCAD, and ANSYS software. They are also trained in characterizing the microstructure of materials using optical microscope interfaced with image analyzer, hardness tester after making heat treatment such as quenching and tempering, induction hardening and normalizing. These kinds of laboratory trainings are very essential to work in various industries. The departmental project allows students to develop innovative concepts such as robot, automated cars and solar powered equipments and alternate fuel development etc.



## PATRONS

Sri. V.M.M. Sainadh Reddy, President,  
Sri. J. Suryaachandra Rao, Vice President,  
Sri. K. Durga Srinivas, Secretary,  
Sri. D. Venkata Rao, Treasurer,  
Sri. P. Durga Prasad Raju, Joint Secretary,  
Sri. S. Srinivasa Rao, Correspondent



## CHAIRMAN

Dr. Y. Srinivasa rao,  
Principal, SSCE

## ORGANISING COMMITTEE

Dr. S. Laxmana Raju  
Head of the Department

## Program Co-ordinator

Mr. M. Ravi Teja, Assistant professor  
Mobile 998508526  
Email: gara352@gmail.com

## SRI SIVANI COLLEGE OF ENGINEERING

(Under the Management of Sri Sivani Educational Society, Srikakulam)

(Approved by AICTE, New Delhi and Affiliated to JNTUGV, Vizianagaram-CC-W6, UGC Recognition under 2(f) & 12(B), ISO 9001:2015 Certified)  
NH-16, Chilakapalem Jn., Srikakulam Dist.532410

## SRI SIVANI COLLEGE OF ENGINEERING

A Two-Week Add-On Program on  
"4th industrial revolution using  
Industry 4.0"

3/4/2023 to 15/4/2023

ORGANIZED BY

DEPARTMENT OF MECHANICAL  
ENGINEERING





## Objective of the Program

The "4th Industrial Revolution using Industry 4.0" add-on program is designed to immerse students in the transformative technologies and methodologies associated with Industry 4.0. The objective is to equip students with a profound understanding of the fourth industrial revolution, fostering the development of skills necessary for a future where smart technologies, data analytics, and automation reshape industries.

## Resource Person

Mr. G. Mahendra Nath, M.Tech(PhD)

Asst. Professor,

Sri Venkateswara College of Engineering and technology

mahindranath.golive@gmail.com

9908840748

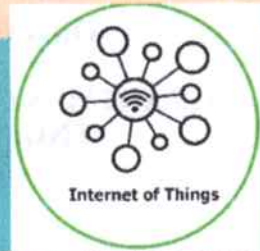

## PROGRAM CONTENT

- **Fundamentals of Industry 4.0:**  
A deep dive into the core concepts of Industry 4.0, including IoT, AI, and robotics
- **Industry 4.0 in Manufacturing:**  
Exploration of smart factories, automation, and digital twins in manufacturing
- **Data-Driven Decision Making:**  
How data analytics and AI are transforming decision-making processes
- **Supply Chain Resilienc:**  
Insights into building resilient supply chains using Industry 4.0 technologies.
- **Case Studies and Best Practices:**  
Learning from industry case studies and best practices for successful implementation.

## REGISTRATION FORM

### A TWO-ADD-ON PROGRAM ON "4TH INDUSTRIAL REVOLUTION USING INDUSTRY 4.0"

**Participant's Name:**

**Gender: Male/Female**

**Educational Qualifications:**

**Department:**

**Organization:**

**Address for Communication:**

**Phone No:**

**Email:**

**Date:**

**Signature of the Participant:**

### INDUSTRY 1.0

Mechanization, steam power, weaving loom



### INDUSTRY 2.0

Mass production, assembly line, electrical energy

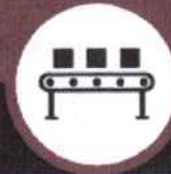

### INDUSTRY 3.0

Automation, computers and electronics

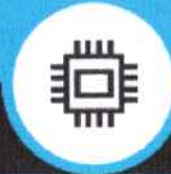

### INDUSTRY 4.0

Cyber Physical Systems, internet of things, networks







# SRI SIVANI COLLEGE OF ENGINEERING

(Under the Management of Sri Sivani Educational Society, Srikakulam)  
(Approved by AICTE, New Delhi and Affiliated to JNTUGv, Vizianagaram-CC-W6,  
UGC Recognition under 2(f) & 12(B), ISO 9001:2015 Certified)  
NH-16, Chilakapalem Jn., SrikakulamDist -532410

## Department of Mechanical Engineering

Academic Year: 2022 – 2023

Date: 3/4/2023

### LIST OF ENROLLED STUDENTS

Name of the Program: A Two Week Add-on Program on 4<sup>th</sup> industrial revolution using  
Industry 4.0.

Sl.No	Roll.No.	Name of the Student	Year/Sem	Signature
1	19W61A0301	Abothula Govinda Rao	IV/II	A. Govinda Rao
2	19W61A0303	Ganagalla Ganesh	IV/II	G. Ganesh
3	19W61A0304	Ganagalla Pavan Surya	IV/II	G. Pavan Surya
4	19W61A0306	Konna Bharath Chakravarthi	IV/II	K. Bharath Chakravarthi
5	19W61A0307	Kunapalli Aravind	IV/II	K. Aravind
6	19W61A0309	Lingala Bhaskara Rao	IV/II	L. Bhaskara Rao
7	19W61A0310	Marpu Mani Durga Prasad	IV/II	M. Mani Durga Prasad
8	19W61A0311	Meesala.Durga Prasad	IV/II	M. Durga Prasad
9	19W61A0312	Pondara Abhinash	IV/II	P. Abhinash
10	19W61A0314	Savara.Simha Chalam	IV/II	S. Simbachalam
11	20W65A0301	Buddepu Chandra Sekhar	IV/II	B. Chandra Sekhar
12	20W65A0303	Dasari Ravikiran	IV/II	D. Ravikiran
13	20W65A0305	Gouthu Uday Kumar	IV/II	G. Uday Kumar
14	20W65A0306	Gunda Haresh	IV/II	G. Haresh
15	20W65A0307	Kallepalli Pavan Kumar	IV/II	K. Pavan Kumar
16	20W65A0308	Karri Saikrishna	IV/II	K. Saikrishna
17	20W65A0309	Kella Koteswara Rao	IV/II	K. Koteswara Rao
18	20W65A0310	Koda Prabhu Dev	IV/II	K. Prabhu Dev
19	20W65A0311	Kottakota Ramu	IV/II	K. Ramu
20	20W65A0312	Kuna Jeevan Kumar	IV/II	K. Jeevan Kumar
21	20W65A0313	Mandala Sobhanbabu	IV/II	M. Sobhanbabu
22	20W65A0315	Pasala Hari Krishna	IV/II	P. Hari Krishna
23	20W65A0316	Patnala Pradeep	IV/II	P. Pradeep
24	20W65A0318	Rokalla Vamsi	IV/II	R. Vamsi
25	20W65A0319	Routhu Nivas	IV/II	R. Nivas
26	20W65A0321	Savirigana Chinna Rao	IV/II	S. Chinna Rao
27	20W65A0322	Simma Pavan Kalyan	IV/II	S. Pavan Kalyan
28	20W65A0323	Timmala Prasanth	IV/II	T. Prasanth



29	20W65A0325	Uppada Jayaram	IV/II	U. Jayaram
30	20W65A0326	Uttaravalli Vidya Sagar	IV/II	U. Vidya Sagar
31	20W65A0327	Yanda Simhachalam	IV/II	Y. Simhachalam
32	20W61A0301	Arikadaniyelu	III/II	A. Dahiyele
33	20W61A0302	B Praveen Kumar	III/II	B. Praveen Kumar
34	20W61A0303	BasuraGiridhar	III/II	B. Giridhar
35	20W61A0304	BiddikaPalgunarao	III/II	B. Palgunarao
36	20W61A0305	ChinnalaAmarnadh	III/II	C. Amarnadh
37	20W61A0306	DurgaPradhan	III/II	DurgaPradhan
38	20W61A0308	GangarapuSanthosh Kumar	III/II	G. Santhosh Kumar
39	20W61A0311	JallaSai Ganga	III/II	J. Sai Ganga
40	20W61A0313	KaranamAravind Kumar	III/II	K. Aravind Kumar
41	20W61A0315	KottubadiJagadeesh	III/II	K. Jagadeesh
42	20W61A0316	KoyyanaHarshavardhan	III/II	K. Harshavardhan
43	20W61A0317	LenkaManikantha	III/II	L. Manikantha
44	20W61A0318	MandareddyLokesh	III/II	M. Lokesh
45	20W61A0319	Muchi Naveen	III/II	M. Naveen
46	20W61A0320	Potnuru Sunil Sai	III/II	P. Sunil Sai
47	20W61A0322	Puti Anil Kumar	III/II	P. Anil Kumar
48	20W61A0323	RituhuPradhan	III/II	R. Pradhan
49	20W61A0324	Sadhu Jagadeesh	III/II	S. Jagadeesh
50	20W61A0325	SiddeswaraAkhil	III/II	S. Akhil
51	20W61A0326	SimmaHemanth Kumar	III/II	S. Hemanth Kumar
52	20W61A0327	SiripuramBhujangarao	III/II	S. Bhujangarao
53	20W61A0328	SuravarapuYeswanth	III/II	S. Yeswanth
54	20W61A0329	ValluruLokesh	III/II	V. Lokesh
55	20W61A0330	VelamalaRavindra	III/II	V. Ravindra
56	20W61A0331	VibhudiVamsi	III/II	V. Vamsi
57	21W65A0302	Besi Krishna Rao	III/II	B. Krishna Rao
58	21W65A0303	BogiPradeepkumar	III/II	B. Pradeep Kumar
59	21W65A0304	CheepuruSaiprasad	III/II	C. Saiprasad
60	21W65A0305	GangitlaHarinath	III/II	G. Harinath
61	21W65A0306	GantyadaLokesh	III/II	G. Lokesh
62	21W65A0307	Gara Anil	III/II	G. Anil
63	21W65A0308	GoliviDhanaDileep	III/II	G. Anil
64	21W65A0309	GuntamukkalaMeharMourya	III/II	G. Mehar Mourya
65	21W65A0310	JalumuruThirumalarao	III/II	J. Thirumalarao
66	21W65A0312	KalluriChandu	III/II	K. Chandu
67	21W65A0313	LoluguSivendra	III/II	L. Sivendra
68	21W65A0314	Maddili Ganesh	III/II	M. Ganesh

69	21W65A0315	MamidiJayadev	III/II	M. Jaydev
70	21W65A0318	PanapanaRanjith	III/II	P. Ranjith
71	21W65A0319	RatnalaRakesh	III/II	R. Rakesh
72	21W65A0321	TammineniSaiSantosh	III/II	T. Sai Santosh
73	21W65A0322	ThotaAvinash	III/II	T. Avinash
74	21W65A0324	Burela Naveen	III/II	B. Naveen

V. Ravi Teja  
Program Coordinator

  
Head of the Department











Sl.No	Roll.No.	Name of the Student	01	02	03	04	05	06	07	08	09	10	11
			3/4	4/4	5/4	6/4	8/4	9/4	10/4	11/4	12/4	13/4	15/4
66	21W65A0312	Kalluri Chandu	P	P	P	P	P	A	P	P	P	P	P
67	21W65A0313	Lolugu Sivendra	P	A	P	P	P	P	P	P	P	P	P
68	21W65A0314	Maddili Ganesh	P	P	A	P	P	P	P	P	P	P	P
69	21W65A0315	Mamidi Jayadev	P	P	P	A	P	P	P	P	P	P	P
70	21W65A0318	Panapana Ranjith	P	P	P	P	A	P	P	P	P	P	P
71	21W65A0319	Ratnala Rakesh	P	P	P	P	P	P	P	P	P	P	P
72	21W65A0321	Tammineni Sai Santosh	P	P	P	P	P	A	P	P	P	P	P
73	21W65A0322	Thota Avinash	P	A	P	P	P	P	P	P	P	P	P
74	21W65A0324	Burela Naveen	P	P	P	P	P	A	P	P	P	P	P
Signature			V.R.T	V.R.T	V.R.T	V.R.T	V.R.T	V.R.T	V.R.T	V.R.T	V.R.T	V.R.T	V.R.T

V. Ravi Teja  
Program Coordinator

  
Head of the Department



# SRI SIVANI COLLEGE OF ENGINEERING

(Under the Management of Sri Sivani Educational Society, Srikakulam)  
(Approved by AICTE, New Delhi and Affiliated to JNTUGV, Vizianagaram-CC-W6,  
UGC Recognition under 2(f) & 12(B), ISO 9001:2015 Certified)  
NH-16, Chilakapalem Jn., Srikakulam Dist. Andhra Pradesh -532410

## Department of Mechanical Engineering

Academic Year: 2022 – 2023

Date: 21/04/2023

### PROGRAM REPORT

**Name of the Program**

: A Two week Add-on Program on 4<sup>th</sup> industrial revolution using Industry 4.0.

**Program Duration**

: Two weeks (3/4/2023 to 15/4/2023, 11 days)

**Resource Person Details**

: Mr. G. Mahendra Nath, M.Tech (PhD)  
Asst. Professor, Mechanical Department  
Sri Venkateswara College of Engineering and  
Technology,

Contact Number: 990840748

**Program Coordinator Details**

: Mr.V. Ravi Teja, M.Tech  
Asst. Professor, Mechanical Department  
Sri Sivani College of Engineering, Srikakulam  
Contact Number: 9985085926

**Program Venue**

: Seminar hall, SSCE Block-1

**Program Objectives:**

- to introduce students to the concepts and technologies associated with the fourth industrial revolution.
- to prepare students for the changing landscape of industry by equipping them with knowledge and skills related to automation, Internet of Things, and data-driven decision-making.
- Analyze successful case studies and best practices in the context of Industry 4.0 adoption

**Topics Covered:-**

1. Introduction to Industry 4.0
2. Cyber-Physical Systems (CPS)
3. Internet of Things (IoT) in Manufacturing
4. Big Data and Analytics in Industry 4.0
5. Artificial Intelligence in Manufacturing
6. Digital Twin Technology
7. Augmented Reality (AR) in Smart Factories
8. Cloud Computing in Industrial Processes
9. Additive Manufacturing in Industry 4.0



10. Smart Sensors and Actuators
11. Communication Protocols in Industry 4.0
12. Robotics and Automation in Smart Factories
13. Blockchain in Supply Chain Management
14. Human-Machine Collaboration in Industry 4.0
15. Standards and Security in Industry 4.0
16. Case Studies in Implementing Industry 4.0
17. Predictive Maintenance in Smart Manufacturing
18. 3D Printing and Digital Fabrication
19. Energy Efficiency in Industry 4.0
20. Future Perspectives of Industry 4.0



**Learning Outcomes:**

Upon completion of this course the student will be able to:

- Grasp Industry 4.0 Fundamentals.
- Explore Automation and IoT Technologies.
- Analyze Data-Driven Decision-Making.
- Familiar with Electric vehicle energy management strategies.
- Learn from real-world examples of companies embracing Industry 4.0 technologies.

**Number of Students attended : 74**

*V. Ravi Teja*  
**Program Coordinator**

  
**Head of the Department**



# SRI SIVANI COLLEGE OF ENGINEERING

(Under the Management of Sri Sivani Educational Society, Srikakulam)  
(Approved by AICTE, New Delhi and Affiliated to JNTUGV, Vizianagaram-CC-W6,  
UGC Recognition under 2(f) & 12(B), ISO 9001:2015 Certified)  
NH-16, Chilakapalem Jn., Srikakulam Dist. Andhra Pradesh -532410

## DEPARTMENT OF MECHANICAL ENGINEERING

### certificate of participation

This is to certify that Mr./Ms. M. NAVEEN bearing roll no 20W61A0319  
of III Year II Semester has completed A Two Week Add-On Program on  
“4th industrial revolution using Industry 4.0” during the period 3/4/2023 to 15/4/2023.

*V. Ravi Teja*  
CO-ORDINATOR

*[Signature]*  
HOD

*[Signature]*  
PRINCIPAL





# SRI SIVANI COLLEGE OF ENGINEERING

(Under the Management of Sri Sivani Educational Society, Srikakulam)  
(Approved by AICTE, New Delhi and Affiliated to JNTUGV, Vizianagaram-CC-W6,  
UGC Recognition under 2(f) & 12(B), ISO 9001:2015 Certified)  
NH-16, Chilakapalem Jn., Srikakulam Dist. Andhra Pradesh -532410

## DEPARTMENT OF MECHANICAL ENGINEERING

### certificate of participation

This is to certify that Mr./Ms. K. CHANDU bearing roll no 21W6SA0312  
of III Year II Semester has completed A Two Week Add-On Program on  
“4th industrial revolution using Industry 4.0” during the period 3/4/2023 to 15/4/2023.

*V. Ravi Teja*  
CO-ORDINATOR

*[Signature]*  
HOD

*[Signature]*  
PRINCIPAL



# SRI SIVANI COLLEGE OF ENGINEERING

(Under the Management of Sri Sivani Educational Society, Srikakulam)  
(Approved by AICTE, New Delhi and Affiliated to JNTUGV, Vizianagaram-CC-W6,  
UGC Recognition under 2(f) & 12(B), ISO 9001:2015 Certified)  
NH-16, Chilakapalem Jn., Srikakulam Dist. Andhra Pradesh -532410

## DEPARTMENT OF MECHANICAL ENGINEERING

### certificate of participation

This is to certify that Mr./Ms. K. JEEVAN KUMAR bearing roll no 202165A0312  
of IV Year II Semester has completed A Two Week Add-On Program on  
“4th industrial revolution using Industry 4.0” during the period 3/4/2023 to 15/4/2023.

V. Rami Teja.  
CO-ORDINATOR

  
HOD

  
PRINCIPAL





# SRI SIVANI COLLEGE OF ENGINEERING

(Under the Management of Sri Sivani Educational Society, Srikakulam)  
(Approved by AICTE, New Delhi and Affiliated to JNTUGV, Vizianagaram-CC-W6,  
UGC Recognition under 2(f) & 12(B), ISO 9001:2015 Certified)  
NH-16, Chilakapalem Jn., Srikakulam Dist. Andhra Pradesh -532410

Date: 03-04-2023

## CIRCULAR

The Department of Civil Engineering is pleased to inform the 2<sup>nd</sup> and 3<sup>rd</sup> year Civil students about conducting A **Two-Week Add-On program on “Modeling of Drinking water Distribution Systems using EPANET”** for their enrichment in the field of modeling. This program is scheduled from **10-04-2023 to 21-04-2023** in the Central Computing Lab, Block I. EPANET is a software application used throughout the world to model water distribution systems. It was developed as a tool for understanding the movement and fate of drinking water constituents within distribution systems, and can be used for many different types of applications in distribution systems analysis.

Today, Engineers and Consultants use EPANET to design and size new water infrastructure, retrofit existing aging infrastructure, optimize operations of tanks and pumps, reduce energy usage, investigate water quality problems, and prepare for emergencies. In this regard, all the 2<sup>nd</sup> and 3<sup>rd</sup> year Civil students are requested to participate and benefit from the same. Complete the Registration process on or before 10-04-2023.



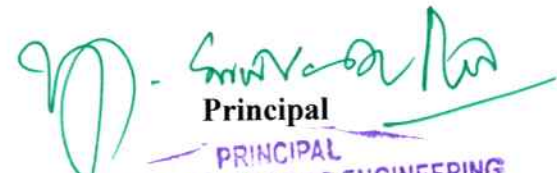

**Venue:** Central Computing Lab, Block – 1, SSCE.

**Co-ordinator:** Mr. N Sai Krishna, Assistant Professor

Department of Civil Engineering

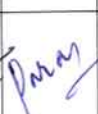
  
**Principal**  
PRINCIPAL  
SRI SIVANI COLLEGE OF ENGINEERING  
Chilakapalem Jn., SRIKAKULAM

### Copy to

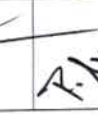
Dept.	IQAC	Civil	EEE	Mech	ECE	CSE	H&BS	MBA	TPO	Office	Library
Signature											

CC To: The Management: for information.



# SRI SIVANI COLLEGE OF ENGINEERING

(Under the Management of Sri Sivani Educational Society, Srikakulam)  
(Approved by AICTE, New Delhi and Affiliated to JNTUGV, Vizianagaram-CC-W6,  
UGC Recognition under 2(f) & 12(B), ISO 9001:2015 Certified)  
NH-16, Chilakapalem Jn., Srikakulam Dist. Andhra Pradesh -532410

## Department of Civil Engineering

Academic year: 2022-23

Date: 03-04-2023

Name of the program: A Two-Week Add-On Program on “Modeling of Drinking water Distribution Systems using EPANET”

### PROGRAM SCHEDULE

S NO	Date	Topic To Be Covered
1	10-04-2023	Module 1: <ul style="list-style-type: none"><li>• Basic of water supply scheme</li><li>• Components</li><li>• Design principle</li><li>• Hydraulic</li></ul>
2	11-04-2023	Module 2: <ul style="list-style-type: none"><li>• Basic of EPANET</li><li>• Introduction</li></ul>
3	12-04-2023	<ul style="list-style-type: none"><li>• Workspace intro</li><li>• Simple network model</li></ul>
4	13-04-2023	Module 3: <ul style="list-style-type: none"><li>• Steady state analysis</li><li>• Introduction</li></ul>
5	15-04-2023	<ul style="list-style-type: none"><li>• Draw one network</li><li>• Analysis of the network</li></ul>
6	17-04-2023	<ul style="list-style-type: none"><li>• Results in different format</li><li>• Hands on session</li></ul>
7	18-04-2023	Module 4: <ul style="list-style-type: none"><li>• Extended period analysis</li><li>• Introduction</li><li>• Draw one network</li></ul>
8	19-04-2023	<ul style="list-style-type: none"><li>• Analysis of the network</li><li>• Hands on session</li></ul>
9	20-04-2023	Module 5: <ul style="list-style-type: none"><li>• Water quality analysis</li><li>• Introduction</li><li>• Draw one network</li></ul>
10	21-04-2023	<ul style="list-style-type: none"><li>• Analysis of the network</li><li>• Results in different format</li><li>• Hands on session</li></ul>

  
Program Co-ordinator

  
Head of the Department



## ABOUT THE INSTITUTION

Sri Sivani College of Engineering (SSCE) is one of the colleges functioning under Sri Sivani Educational Society, established in 2006 affiliated to JNTUGV, Vizianagaram. UGC Recognition under 2(f) & 12(B). ISO 9001:2015 Certified. SSCE is situated in a spacious 12 acres campus adjacent to NH-16 at Chilakapalem, Srikakulam, Andhra Pradesh.

SSCE offers B. Tech programs in Civil, C.S.E, E.E.E, E.C.E, Mechanical Engineering and PG programmes M.B.A, M.Tech and Diploma programmes for Civil, E.E.E and Mechanical Engineering. Fully connected through Fiber Optics and Wi-Fi Networks, Endowed with fully Qualified, well experienced and seasoned faculty members equipped with industrial experience and fully established laboratories with state-of-the-art technologies meets the growing needs of the students.

## ABOUT THE DEPARTMENT

The Department of CIVIL Engineering was established in the academic year 2009-10 with an annual intake of 30. The Department is accredited by AICTE, Delhi. The Department focuses on preparing the students for wide range of IT careers equipping them with unique enriching experience of molding tomorrow's technocrats with high caliber and commitment.

B.Tech. in Civil includes study of various aspects of civil engineering to meet the requirements of the various industries. The course contains study of the different civil engineering subjects such as structural, geotechnical, hydraulics, transportation etc. and its application, as well as the detailed study of civil engineering materials and their characteristics. The course of B.Tech in civil engineering trains an individual in the fields related to civil engineering structures and constructions. The four-year course that lead to a degree in Bachelor of Technology (B.Tech.), adopt a University-mandated semester system of 8 semesters. Each semester is of 16 weeks duration. University examinations are held at the end of each semester.

## PATRONS

Sri V.M.M. Sainadh Reddy, President,  
Sri. J. Suryachandra Rao, Vice President,  
Sri. K. Durga Srinivas, Secretary,  
Sri. D. Venkata Rao, Treasurer,  
Sri. P. Durga Prasad Raju, Joint Secretary,  
Sri. S. Srinivasa Rao, Correspondent



### CHAIRMAN

Dr. Y. Srinivasa Rao,  
Principal, SSCE

### ORGANISING COMMITTEE CONVENOR

Mr. G. Parasuram  
Head of the Department

### Program Co-ordinator

Mr. N. Saikrishna

Assistant professor  
[krishnacivil137@gmail.com](mailto:krishnacivil137@gmail.com)  
8639137837

## SRI SIVANI COLLEGE OF ENGINEERING

(Under the Management of Sri Sivani Educational Society,  
Srikakulam) (Approved by AICTE, New Delhi and Affiliated to  
JNTUGV, Vizianagaram-CC-W6,  
UGC Recognition under 2(f) & 12(B), ISO 9001:2015 Certified)  
NH-16, Chilakapalem, Jn., Srikakulam Dist. Andhra Pradesh  
-532410

## SRI SIVANI COLLEGE OF ENGINEERING

### A Two-Week Add-On Program

on

"Modeling of Drinking water Distribution  
Systems using EPANET"  
10-04-2023 to 21-04-2023

ORGANIZED BY

DEPARTMENT  
OF  
CIVIL ENGINEERING





## Objective of the Program

- Impart basic knowledge of analysis of water distribution networks.
- Provide knowledge of EPANET Software to perform analysis of pipe networks.
- Tracks the flow of water in each pipe, the pressure at each node, the height of the water in each tank, a chemical concentration, the age of the water, and source tracing throughout the network during a simulation period.
- Provide hands on experience on EPANET Software.

## Resource Person

Mr. S V N Sunil Kumar

*M.S – Environmental Engineering*

*Assistant Professor*

*Department of Civil Engineering*

*SSCE, Chilakapalem*

*[srigirisetty.sunil@gmail.com](mailto:srigirisetty.sunil@gmail.com)*

*Mobile-8978060684*

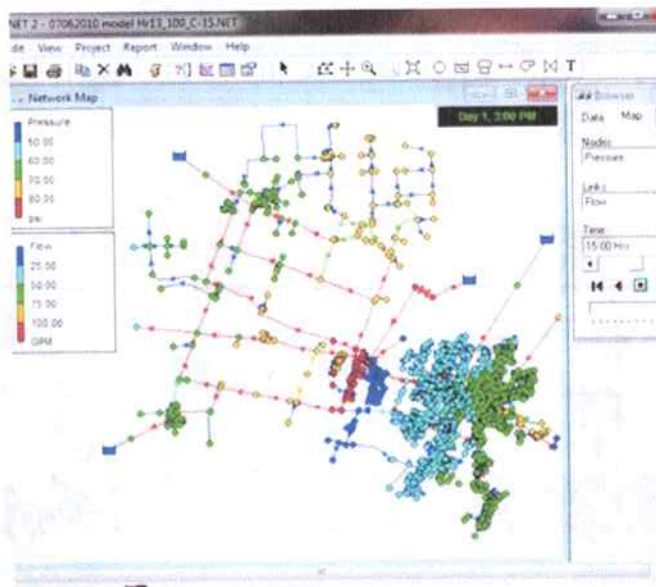

## TOPICS TO BE COVERED

### Module 1:

- Basic of water supply scheme
- Components
- Design principle
- Hydraulic

### Module 2:

- Basic of EPANET
- Introduction
- Workspace intro
- Simple network model

### Module 3:

- Steady state analysis
- Introduction
- Draw one network
- Analysis of the network
- Results in different format
- Hands on session

### Module 4:

- Extended period analysis
- Introduction
- Draw one network
- Analysis of the network
- Hands on session

### Module 5:

- Water quality analysis
- Introduction
- Draw one network
- Analysis of the network
- Results in different format
- Hands on session



## REGISTRATION FORM

A TWO-WEEK ADD-ON PROGRAM  
ON  
"MODELING OF DRINKING WATER  
DISTRIBUTION SYSTEMS USING  
EPANET"

Participant's Name:

Gender: Male/Female

Educational Qualifications:

Department:

Organization:

Address for Communication:

Phone No:

Email:

Date:

Signature of the Participant:

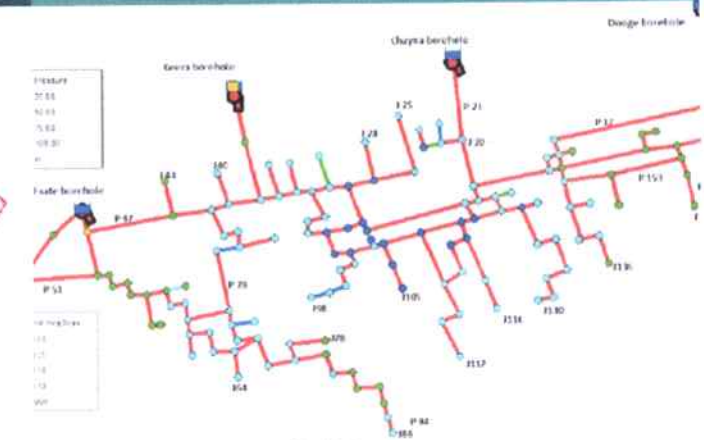





# SRI SIVANI COLLEGE OF ENGINEERING

(Under the Management of Sri Sivani Educational Society, Srikakulam)  
(Approved by AICTE, New Delhi and Affiliated to JNTUGV, Vizianagaram-CC-W6,  
UGC Recognition under 2(f) & 12(B), ISO 9001:2015 Certified)  
NH-16, Chilakapalem Jn., Srikakulam Dist. Andhra Pradesh -532410

## Department of Civil Engineering

Academic year: 2022-23

Date: 10-04-2023

Name of the program: A Two-Week Add-On Program on “Modeling of Drinking water  
Distribution Systems using EPANET”

### List of Enrolled Students

S.No	Roll No	Name of the student	Year-Sem	Signature
1	20W61A0102	Arasavelli Jhansi	III-II	A. Jhansi
2	20W61A0105	B Maheshwara Rao	III-II	B. maheshwararao
3	20W61A0108	Duppatala Shakil	III-II	D. shakil
4	20W61A0110	Kadupuri Neeraja	III-II	K. Neeraja
5	20W61A0111	Neduru Siddhu Ganesh	III-II	N. Siddhu Ganesh
6	20W61A0112	P Pavankumar	III-II	P. Pavan Kumar
7	20W61A0113	Runku Siva Kiran	III-II	R. Siva Kiran
8	20W61A0114	Savara Venkata Rao	III-II	S. Venkata Rao
9	20W61A0118	Thandra Rakesh	III-II	T. Rakesh
10	20W61A0119	Thota Dhanunjay Rao	III-II	T. Dhanunjay Rao
11	21W65A0102	Bora Vijaykumar	III-II	B. vijay kumar
12	21W65A0103	Dikkala Karthik	III-II	D. karthik
13	21W65A0105	K Vinayakumar	III-II	K. Vinay Kumar
14	21W65A0107	Kundu Devi	III-II	K. Devi
15	21W65A0108	Madini Bhargava	III-II	M. Bhargava
16	21W65A0109	Palli Ramu	III-II	P. RAMU
17	21W65A0110	Piriya Sateesh Kumar	III-II	P. Sateesh
18	21W65A0111	Ponnana Ajay	III-II	P. AJAY
19	21W65A0112	Pudi Suresh	III-II	P. Suresh

20	21W65A0114	Sadu Shanmuka Rao	III-II	S. Shanmuka rao
21	21W65A0115	Sanapala Santharam	III-II	S. Santharam.
22	21W65A0116	Savara Tirupathirao	III-II	S. Tirupathirao
23	21W65A0117	S Guna Sekhar	III-II	S. Guna sekhar
24	21W65A0118	V Sudarshan Raju	III-II	V. Sudarshan Raju
25	20B41A0101	Parapathi Raghu	III-II	P. Raghu
26	21W61A0101	Bonela Aravind	II-II	B. Aravind.
27	21W61A0102	B Jagannadharao	II-II	B. Jagannadharao
28	21W61A0103	Ch. Jagadeesh Kumar	II-II	Ch. Jagadeesh
29	21W61A0106	Lingala Yuvaraj	II-II	L. Yuvaraj
30	21W61A0107	Muddada Maneesha	II-II	M. Maneesha
31	21W61A0109	R Kumara Swami	II-II	R. Kumer Swami
32	21W61A0111	Sadhu Jyothi Swaroop	II-II	S. Jyothi Swaroop
33	21W61A0112	S Veerendraswamynath	II-II	S. veerendra
34	21W61A0113	Vambaravalli Siva	II-II	V. Siva
35	22W65A0101	Butcha Vekatesh	II-II	B. Venkatesh.
36	22W65A0102	Challa Vijaya Raju	II-II	Ch. Vijaya Raju
37	22W65A0103	Chelluru Raviraj	II-II	Ch. Raviraj
38	22W65A0104	Gondu Vishnu Vardhan	II-II	G. Vishnu Vardhan.
39	22W65A0106	Jada Siva Sai Krishna	II-II	J. Siva sai
40	22W65A0107	K Dhanush Kumar	II-II	K. Dhanush
41	22W65A0108	Karanam Sai Kumar	II-II	K. Sai Kumar

  
Program Co-ordinator

  
Head of the Department





19	21W65A0112	Pudi Suresh	P	P	P	P	P	P	P	P	P	P
20	21W65A0114	Sadu Shanmuka Rao	P	P	P	P	P	P	P	P	P	P
21	21W65A0115	Sanapala Santharam	P	P	P	P	P	P	P	P	P	P
22	21W65A0116	Savara Tirupathirao	P	P	P	AB	P	P	P	P	P	P
23	21W65A0117	S Guna Sekhar	P	P	P	P	P	P	P	P	P	P
24	21W65A0118	V Sudarshan Raju	P	P	P	P	P	P	P	P	P	P
25	20B41A0101	Parapathi Raghu	P	P	P	AB	P	P	P	P	P	P
26	21W61A0101	Bonela Aravind	P	P	P	P	P	P	P	P	P	P
27	21W61A0102	B Jagannadharao	P	P	P	P	P	P	P	P	P	P
28	21W61A0103	Ch. Jagadeesh Kumar	P	P	P	P	P	P	P	P	P	P
29	21W61A0106	Lingala Yuvaraj	P	P	P	P	P	P	P	P	P	P
30	21W61A0107	Muddada Maneesha	P	P	P	P	P	P	P	P	P	P
31	21W61A0109	R Kumara Swami	P	P	P	P	P	P	P	P	P	P
32	21W61A0111	Sadhu Jyothi Swaroop	P	P	P	P	P	P	P	P	P	P
33	21W61A0112	S Veerendraswamynath	P	P	P	P	P	P	P	P	P	P
34	21W61A0113	Vambaravalli Siva	P	P	P	P	P	P	AB	P	P	P
35	22W65A0101	Butcha Vekatesh	P	P	P	P	P	P	AB	P	P	P
36	22W65A0102	Challa Vijaya Raju	P	P	P	P	P	P	P	P	P	P
37	22W65A0103	Chelluru Raviraj	P	P	AB	AB	P	AB	AB	AB	AB	P
38	22W65A0104	Gondu Vishnu Vardhan	P	P	P	P	P	P	P	P	P	P
39	22W65A0106	Jada Siva Sai Krishna	P	P	P	P	P	P	P	P	P	P
40	22W65A0107	K Dhanush Kumar	P	AB	AB	AB	P	AB	AB	AB	AB	AB
41	22W65A0108	Karanam Sai Kumar	P	P	P	P	P	P	P	P	P	P
Signature			N	N	N	N	N	N	N	N	N	N

  
**Program Co-ordinator**





# SRI SIVANI COLLEGE OF ENGINEERING

(Under the Management of Sri Sivani Educational Society, Srikakulam)  
(Approved by AICTE, New Delhi and Affiliated to JNTUGV, Vizianagaram-CC-W6,  
UGC Recognition under 2(f) & 12(B), ISO 9001:2015 Certified)  
NH-16, Chilakapalem Jn., Srikakulam Dist. Andhra Pradesh -532410

## Department of Civil Engineering

Academic year: 2022-23

Date: 25-04-2023

### PROGRAM REPORT

- **Name of the program:** A Two-Week Add-On Program on “Modeling of Drinking water Distribution Systems using EPANET”
- **Program Duration:** 10-04-2023 to 21-04-2023
- **Name of the Resource Person:**
  - Mr. S V N Sunil Kumar
  - M.S – Environmental Engineering
  - Assistant Professor
  - Department of Civil Engineering
  - SSCE, Chilakapalem
  - [srigirisetty.sunil@gmail.com](mailto:srigirisetty.sunil@gmail.com)
  - 8978060684
- **Details of the Program Coordinator:**
  - N Sai Krishna
  - M.Tech – Transportation Engineering
  - Asst. Professor
  - Department of Civil Engineering
  - SSCE, Chilakapalem
  - [krishnacivil137@gmail.com](mailto:krishnacivil137@gmail.com)
  - 8639137837
- **Objectives of the Program:**
  - ✓ Impart basic knowledge of analysis of water distribution networks.
  - ✓ Provide knowledge of EPANET Software to perform analysis of pipe networks.
  - ✓ Tracks the flow of water in each pipe, the pressure at each node, the height of the water in each tank, a chemical concentration, the age of the water, and source tracing throughout the network during a simulation period.
  - ✓ Provide hands on experience on EPANET Software.

- **Topics Covered**

Module 1:

- Basic of water supply scheme
- Components
- Design principle
- Hydraulic

Module 2:

- Basic of EPANET
- Introduction
- Workspace intro
- Simple network model

Module 3:

- Steady state analysis
- Introduction
- Draw one network
- Analysis of the network
- Results in different format
- Hands on session

Module 4:

- Extended period analysis
- Introduction
- Draw one network
- Analysis of the network
- Hands on session

Module 5:

- Water quality analysis
- Introduction
- Draw one network
- Analysis of the network
- Results in different format
- Hands on session







- **Outcomes of the Program: On completion of this program, student can:**
  - ✓ Draw a network representing water distribution system.
  - ✓ Find the pipe discharges and hydraulic heads of each node by giving required input parameters.
  - ✓ Observe the uncertainties in discharge and pressure (HGL) for the real network
  - ✓ Understands the movement and fate of drinking water constituents within distribution systems.
  - ✓ Perform extended-period simulation of the hydraulic and water quality behavior within pressurized pipe networks, which consist of pipes, nodes (junctions), pumps, valves, storage tanks, and reservoirs.
  
- **Number of participants: 41**

  
Program Co-ordinator

  
Head of the Department





# SRI SIVANI COLLEGE OF ENGINEERING

(Under the Management of Sri Sivani Educational Society, Srikakulam)

(Approved by AICTE, New Delhi and Affiliated to JNTUGV, Vizianagaram-CC-W6,

UGC Recognition under 2(f) & 12(B), ISO 9001:2015 Certified)

NH-16, Chilakapalem Jn., Srikakulam Dist. Andhra Pradesh -532410

## CERTIFICATE OF PARTICIPATION

This is to certify that Mr./Ms. Muddada Maneesha bearing  
Roll No 21W61A0107 of II Year II Semester has completed  
A Two-Week Add-On Program on "Modeling of Drinking water Distribution Systems using  
EPANET" during the period 10-04-2023 to 21-04-2023 organized by Department of Civil  
Engineering.

  
Co-Ordinator

  
HOD

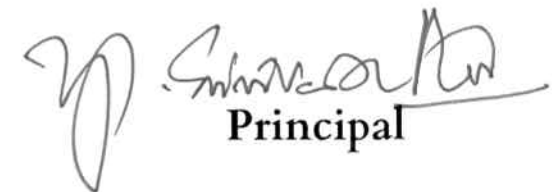
  
Principal



# SRI SIVANI COLLEGE OF ENGINEERING

(Under the Management of Sri Sivani Educational Society, Srikakulam)

(Approved by AICTE, New Delhi and Affiliated to JNTUGV, Vizianagaram-CC-W6,

UGC Recognition under 2(f) & 12(B), ISO 9001:2015 Certified)

NH-16, Chilakapalem Jn., Srikakulam Dist. Andhra Pradesh -532410

## CERTIFICATE OF PARTICIPATION

This is to certify that Mr./Ms. Savara Venkata Rao bearing  
Roll No 204161AD114 of III Year II Semester has completed  
A Two-Week Add-On Program on "Modeling of Drinking water Distribution Systems using  
EPANET" during the period 10-04-2023 to 21-04-2023 organized by Department of Civil  
Engineering.

  
Co-Ordinator

  
HOD

  
Principal





# SRI SIVANI COLLEGE OF ENGINEERING

(Under the Management of Sri Sivani Educational Society, Srikakulam)

(Approved by AICTE, New Delhi and Affiliated to JNTUGV, Vizianagaram-CC-W6,

UGC Recognition under 2(f) & 12(B), ISO 9001:2015 Certified)

NH-16, Chilakapalem Jn., Srikakulam Dist. Andhra Pradesh -532410

## CERTIFICATE OF PARTICIPATION

This is to certify that Mr./Ms. Thandra Rakesh bearing  
Roll No 20W61A0118 of III Year II Semester has completed  
A Two-Week Add-On Program on "Modeling of Drinking water Distribution Systems using  
EPANET" during the period 10-04-2023 to 21-04-2023 organized by Department of Civil  
Engineering.

  
Co-Ordinator

  
HOD

  
Principal



# SRI SIVANI COLLEGE OF ENGINEERING

(Under the Management of Sri Sivani Educational Society, Srikakulam)

(Approved by AICTE, New Delhi and Affiliated to JNTUGV, Vizianagaram-CC-W6,

UGC Recognition under 2(f) & 12(B), ISO 9001:2015 Certified)

NH-16, Chilakapalem Jn., Srikakulam Dist. Andhra Pradesh -532410

## CERTIFICATE OF PARTICIPATION

This is to certify that Mr./Ms. Lingala Yuvaraj bearing  
Roll No 21W61A0106 of II Year II Semester has completed  
A Two-Week Add-On Program on "Modeling of Drinking water Distribution Systems using  
EPANET" during the period 10-04-2023 to 21-04-2023 organized by Department of Civil  
Engineering.

  
Co-Ordinator

  
HOD

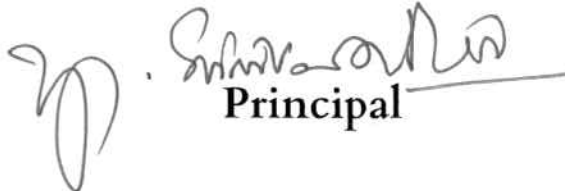
  
Principal





# SRI SIVANI COLLEGE OF ENGINEERING

(Under the Management of Sri Sivani Educational Society, Srikakulam)  
(Approved by AICTE, New Delhi and Affiliated to JNTUGV, Vizianagaram-CC-W6,  
UGC Recognition under 2(f) & 12(B), ISO 9001:2015 Certified)  
NH-16, Chilakapalem Jn., Srikakulam Dist -532410

Date: 01-05-2023

## CIRCULAR

Here by informed to all the 1<sup>st</sup> year ECE, EEE & AIML students that, the Department of Humanities and Basics Science are planning to organize **A Two-week ADD-ON Program on "Statistical Distributions"** from **08-05-2023 to 19-05-2023**. This program is aimed at enhancing your skills and knowledge. In this regard, I suggest all students should enroll this program on or before **04-05-2023**.











**Venue:** Seminar Hall, Block – 1, SSCE.

**Co-ordinator:** Mrs. R. Naga Mani, Asst. Prof,

Department of Humanities and Basics Sciences

  
Principal  
PRINCIPAL  
SRI SIVANI COLLEGE OF ENGINEERING  
Chilakapalem Jn., SRIKAKULAM

### Copy to

Dept.	IQAC	Civil	EEE	Mech	ECE	CSE	H&BS	MBA	TPO	Office	Library
Signature											

CC To: The Management: for information.



# SRI SIVANI COLLEGE OF ENGINEERING

(Under the Management of Sri Sivani Educational Society, Srikakulam)  
(Approved by AICTE, New Delhi and Affiliated to JNTUGV, Vizianagaram-CC-W6,  
UGC Recognition under 2(f) & 12(B), ISO 9001:2015 Certified)  
NH-16, Chilakapalem Jn., Srikakulam Dist -532410

## DEPARTMENT OF HUMANITIES & BASIC SCIENCES

Academic Year : 2022-23

Date: 01-05-2023

Name of the program: A Two-week Add-On Program on "Statistical Distributions."

### PROGRAM SCHEDULE

S.No	Date	Topics To Be Covered
1	08-05-2023	Introduction
2	09-05-2023	Conditional Probabillity
3	10-05-2023	Bayes theorem
4	11-05-2023	Binomial Distribution
5	12-05-2023	Poission Distribution
6	13-05-2023	Normal Distribution
7	15-05-2023	Normal Distribution
8	16-05-2023	Properties
9	17-05-2023	Moment generating function
10	18-05-2023	Sampling Distributions
11	19-05-2023	Sampling Distributions

  
Program Co-ordinator

  
Head of the Department



## ABOUT THE INSTITUTION

Sri Sivani College of Engineering (SSCE) is one of the colleges functioning under Sri Sivani Educational Society. SSCE is a pioneer in the field of engineering education in Srikakulam district (A.P). It was established in the year 2006 under the affiliation of JNT UGV, Vizianagaram and approved by AICTE, New Delhi. The college is UGC Recognition under 2(f) & 12(B), ISO 9001:2015 Certified) SSCE is situated in a spacious 11 acres campus adjacent to NH-16 at chilkapalem village. The college is easily accessible to all the districts nearby Srikakulam. SSCE offers B.Tech programmes in E.E.E, E.C.E, C.S.E, Mechanical and Civil Engineering, besides PG programmes M.C.A, M.B.A, M.Tech and Diploma programmes like E.E.E, Mechanical, and Civil Engineering as second shift. SSCE is completely Wi-Fi enabled and equipped with well established laboratories. The college has focused towards student centric learning atmosphere. The faculty is well qualified, experienced equipped with state of art technologies and dedicated to produce marketable products.

## ABOUT THE DEPARTMENT

The Department of Humanities and Basic Sciences, Sri Sivani College of Engineering was established in the year 2006. The department has always been on a progressive path, thanks to the experienced and dedicated faculty members who have a strong commitment towards providing quality engineering education.

### CHIEF PATRON

Sri. V.M.M. Sainadh Reddy, President

### PATRONS

Sri. J. Suryachandra Rao, Vice President

Sri. K. Durga Srinivas, Secretary

Sri. D. Venkata Rao, Treasurer

Sri. P. Durga Prasad Raju, Joint Secretary

Dr. S. Srinivasa Rao, Correspondent

### PRINCIPAL

Dr. Y. Srinivas Rao,

SSCE

### Head of the Department

Mr. K. Madhukumar,

Associate Professor,

Dept. of H&BS

### Program Co-ordinator

Mrs. R. Nagamani, M.Sc

Assistant Professor,

Dept. of H&BS

Sri Sivani College of Engineering

rapaka.nagamani@gmail.com

8074315077

### RESOURCE PERSONS

Mr. K. Koti Babu, M.Sc

Assistant Professor,

Dept. of H&BS

Sri Sivani College of Engineering

kotibabu242@gmail.com

9440561252



## A TWO-WEEK ADD-ON PROGRAM ON "STATISTICAL DISTRIBUTIONS"

*(08th - 19th May 2023)*

Organized by  
Department of Humanities &  
Basic Sciences



**SRI SIVANI  
COLLEGE OF  
ENGINEERING**



## PROGRAM SCHEDULE:

1. Conditional probability
2. Bayes theorem
3. Binomial distribution
4. Poission distribution
5. Normal distribution
6. Properties
7. Moment generating function
8. Sampling distributions

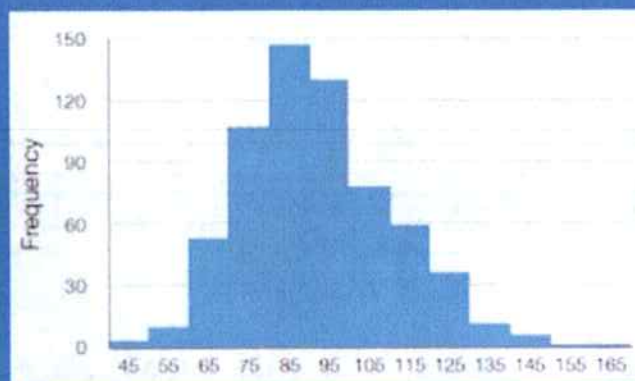
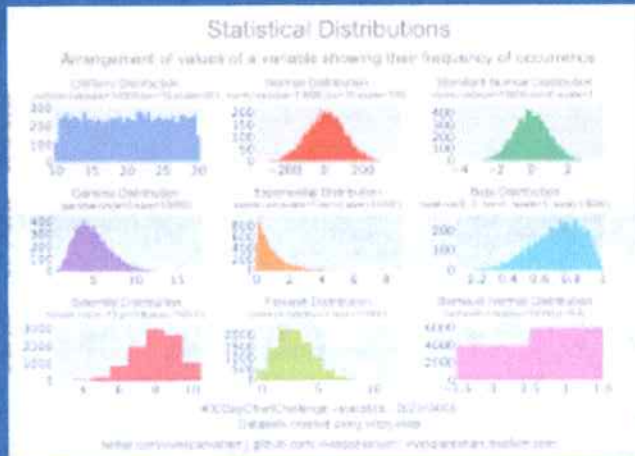

## Probability Distributions

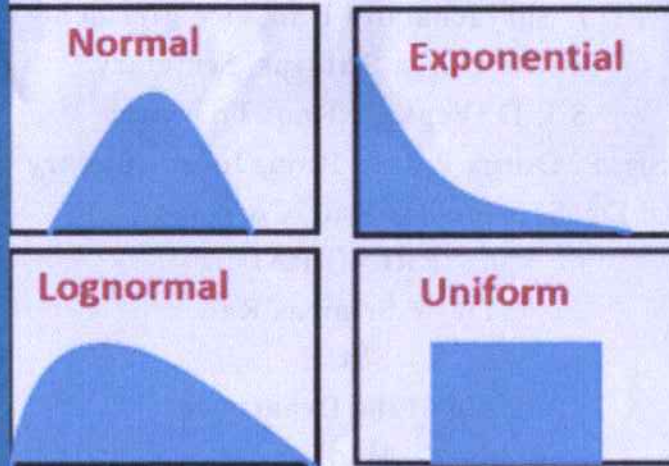

## OBJECTIVES:

1. Understand how the sampling app in steterunch works and why we use it.
2. Understand that the distribution of the data can have many different shapes. Sample size cannot change the shape.
3. The spread of the sample mean is called the standard error and can be calculated with the formula.
4. Student will need to use this app later, to check the reliability of the data analysis.

## REGISTRATION FORM

**A TWO-WEEK ADD-ON  
PROGRAM  
ON  
"STATISTICAL DISTRIBUTIONS"  
(08th - 19th May 2023)**

**Participant's name :**

**Gender: Male/Female :**

**Educational Qualification :**

**Department :**

**Organization:**

**Address for Communication :**

**Mobile Number :**

**Email ID :**

**Date:**

**Signature of the Participant**





# SRI SIVANI COLLEGE OF ENGINEERING

(Under the Management of Sri Sivani Educational Society, Srikakulam)  
(Approved by AICTE, New Delhi and Affiliated to JNTUV, Vizianagaram-CC-W6,  
UGC Recognition under 2(f) & 12(B), ISO 9001:2015 Certified)  
NH-16, Chilakapalem Jn., Srikakulam Dist -532410

## DEPARTMENT OF HUMANITIES & BASIC SCIENCES

Academic Year: 2022-23

Date: 04-05-2023

Name of the program: A Two Week Add-On Program on "Statistical Distributions".

### List Of Enrolled Students

S.No	Roll No	Name Of The Student	Year/Sem	Signature
1	22W61A0201	BARNANA TARAKESWARA	I/II	B. Tarakeswara
2	22W61A0202	DUDDU MOHANA RAO	I/II	D. Mohana Rao
3	22W61A0203	DUNGA GANESH	I/II	D. Ganesh
4	22W61A0204	DUPPALA PURNACHANDRA	I/II	D. PurnaChandra
5	22W61A0205	GULIVENDALA VENKATA	I/II	G. Venkatta
6	22W61A0206	KANUSU SURENDRA	I/II	K. Surendra
7	22W61A0207	KOLLA GAYATRI	I/II	K. Gayatri
8	22W61A0208	KONCHADA RAJU	I/II	K. Raju
9	22W61A0209	PIRIYA ABHIVARUN	I/II	P. Abhivaran
10	22W61A0210	POGIRI SRAVANI	I/II	P. Sravani
11	22W61A0402	ANIPINDI DINESH	I/II	A. Dinesh
12	22W61A0403	ANNEPU PAVAN	I/II	A. Pavan
13	22W61A0404	BAMMIDI AVINASH	I/II	B. Avinash
14	22W61A0407	BODDA AJAY	I/II	B. Ajay
15	22W61A0408	BONGU	I/II	B. B. B.
16	22W61A0409	DAKA SAMEERA	I/II	D. Sameera
17	22W61A0410	DOKKA KOTESWARA RAO	I/II	D. koteswararao
18	22W61A0411	DONTUKURTHU YASODHA	I/II	D. yasodha
19	22W61A0412	GEDELA KIRAN	I/II	G. Kiran
20	22W61A0413	GEDELA PRATAP	I/II	G. pratap
21	22W61A0414	GONDU GAYATHRI	I/II	G. Gayathri
22	22W61A0415	GURUGUBELLI DIVYA	I/II	G. Divya
23	22W61A0416	JARUGULLA	I/II	J. Jarugulla
24	22W61A0417	JOGI KIRAN	I/II	J. Kiran
25	22W61A0418	KALIVARAPU SRAVANI	I/II	K. Raghavendra
26	22W61A0419	KANDHI ERRAMNAIDU	I/II	K. YerramNaidu
27	22W61A0420	KARRI PAVANI	I/II	K. Pavani
28	22W61A0421	KEMBURU NAVEEN	I/II	K. Naveen
29	22W61A0422	KORNU MANOJ	I/II	K. MANOJ
30	22W61A0423	KOTTAVALASA DHANA	I/II	K. DHANA
31	22W61A0424	LINGIBHERI MADHAVI	I/II	L. madhavi
32	22W61A0425	MADDILA NARENDRA	I/II	M. Naveendra
33	22W61A0426	MURAPAKA RAJESH	I/II	M. Rajesh
34	22W61A0427	MYLAPILLI NITISH SAI	I/II	M. Nitish Sai
35	22W61A0428	NAGARAPU VENKATESH	I/II	N. Venkatesh
36	22W61A0429	NAVIRI HARINI	I/II	N. Harini
37	22W61A0430	PALISSETTI SATISH	I/II	P. Satish
38	22W61A0431	PANDRANKI GANESH	I/II	P. Ganesh



S.No	Roll No	Name Of The Student	Year/Sem	Signature
39	22W61A0432	PANGA HEMANTHU	I/II	P. Hemanthu
40	22W61A0433	PONNADA VENKATA SRI	I/II	P. Venkata sri
41	22W61A0434	POTNURU RATNA SRI	I/II	P. RATNA sri
42	22W61A0435	PURIJALA VENKATA	I/II	P. venkata
43	22W61A0436	RAVADA BUTCHI MADHAVA	I/II	R. Butchi madhava
44	22W61A0437	REDDI LIKHITHA	I/II	R. Likhitha
45	22W61A0438	REDDI NITEESHA	I/II	R. Niteesha
46	22W61A0439	SADAGANA TEJESWARI	I/II	S. Tejawari
47	22W61A0440	SASUPALLI PUSHYAMI	I/II	S. Pushyami
48	22W61A0441	SINGUPURAPU BHAVANI	I/II	S. Bhavani
49	22W61A0442	TULAGAPU SANTI	I/II	T. S. SANTI
50	22W61A0443	UBBISETTI NAGABABU	I/II	U. Nagababu
51	22W61A0445	VANDANA SAMRUTHA	I/II	V. SAMRUTHA
52	22W61A0446	VANJANGI SAI KRISHNA	I/II	V. Sai Krishna
53	22W61A0447	VARANASI SIRISHA	I/II	V. Sirisha
54	22W61A0448	AATLA AJAY KUMAR	I/II	A. Ajay kumar
55	22W61A0449	BEHARA MANOHAR SAI	I/II	B. manohar sai
56	22W61A0450	BEHARA YASWANTH SAI	I/II	B. yaswanth sai
57	22W61A0451	VALLE BHAVANI	I/II	V. Bhavani
58	22W61A6101	ABOTHULA KEERTHANA	I/II	A. Keerthana
59	22W61A6102	A. DURGAPRASAD	I/II	A. Durga prasad
60	22W61A6103	ATTADA JASWANTH	I/II	A. Jaswanth
61	22W61A6104	BEHARA JAYENDRA	I/II	B. Jayendra
62	22W61A6105	BEVARA RAJASEKHAR	I/II	BEVARA Rajashekar
63	22W61A6106	BIRLANGI KUMAR	I/II	B. kumar
64	22W61A6107	BONAM TEJESWARI	I/II	B. Tejeswari
65	22W61A6108	BONTHA ARAVIND	I/II	B. ARAVIND
66	22W61A6109	CHALLA SANTHOSH	I/II	C. Santhosh
67	22W61A6110	CHIPURU JOGENDRA	I/II	C. jogendra
68	22W61A6111	CHODAVARAPU BHAVANI	I/II	C. Bhavani
69	22W61A6112	D. GNANESWARA RAO	I/II	D. ganeswarao
70	22W61A6113	DOLA MANIKANTA	I/II	D. mani kanta
71	22W61A6114	GADIDESI MOHANARAO	I/II	G. Mohanrao
72	22W61A6115	GORLE MOUNIKA	I/II	G. mounika
73	22W61A6116	GUDIPADRA PREETHI	I/II	G. preethi
74	22W61A6117	GUDLA MOUSMI	I/II	G. mousmi
75	22W61A6118	JADDU PAVAN KUMAR	I/II	J. Pavan kumar
76	22W61A6119	KANTUBOTHU ARAVIND	I/II	K. Aravind
77	22W61A6120	KETHALA SANJAY	I/II	K. Sanjay
78	22W61A6121	KIMIDI HARIKRISHNA	I/II	K. Harikrishna
79	22W61A6122	KORADA SRIJA	I/II	K. Srija
80	22W61A6124	MAMIDI UDAYA KIRAN	I/II	M. Udaya Kiran
81	22W61A6125	MANDALA BHASHITHA	I/II	M. Bhashitha
82	22W61A6126	MANDALA PALLAVI	I/II	M. pallavi
83	22W61A6127	MEDIMI TARUN	I/II	M. Tarun
84	22W61A6128	MOLLI KOTESWARARAO	I/II	M. Koteswarao
85	22W61A6129	NAMBURI PHANINDRA	I/II	N. phanindra
86	22W61A6131	PAILA SAIKUMAR	I/II	P. Saikumar
87	22W61A6132	PANCHADI KOMALA	I/II	P. Komala



S.No	Roll No	Name of The Student	Year/Sem	Signature
88	22W61A6133	PINNINTI JASMITHA	I/II	P. Jasmitha
89	22W61A6134	PODUGU	I/II	P. Podugu
90	22W61A6135	PYDI JHANSI	I/II	P. Jhansi
91	22W61A6136	RAKOTI VARA PRASAD	I/II	R. Vara Prasad
92	22W61A6137	REDDY ANITA	I/II	R. Anita
93	22W61A6138	SANAPALA VINOD	I/II	S. Chinni Krishna
94	22W61A6139	SEEPANA CHINNI KRISHNA	I/II	S. Chinni Krishna
95	22W61A6140	SEERAPU KAVYA	I/II	S. Kavya
96	22W61A6141	SURU DURGA VENKATA	I/II	S. Venkata
97	22W61A6143	TANGI GNANA DEEPTHI	I/II	T. Gnana Deepthi
98	22W61A6145	VALUROUTHU ANITHA	I/II	Valuroothu-Anitha
99	22W61A6146	VANKAYALA LAXMI	I/II	V. Laxmi
100	22W61A6148	YAMPALLA AJAY KUMAR	I/II	Y. Ajay Kumar
101	22W61A6149	KOTA YASWANTH	I/II	K. Yaswanth
102	22W61A6150	TALAGANA JAYAKRISHNA	I/II	T. Jaya Krishna

  
Program Co-ordinator

  
Head of the Department



# SRI SIVANI COLLEGE OF ENGINEERING

(Under the Management of Sri Sivani Educational Society, Srikakulam)  
 (Approved by AICTE, New Delhi and Affiliated to JNTUV, Vizianagaram CC-W6,  
 UGC Recognition under 2(f) & 12(B), ISO 9001:2015 Certified)  
 NH-16, Chilakapalem Jn., Srikakulam Dist -532410

## DEPARTMENT OF HUMANITIES & BASIC SCIENCES

Academic Year: 2022-23

Program Name: A Two Week Add-On Program on "Statistical Distributions".

### Day Wise Attendance Sheet

S.No	Roll No	Name Of The Student	01 8/05	02 9/05	03 10/5	04 11/05	05 12/05	06 13/5	07 15/05	08 16/05	09 17/5	10 18/5	11 19/5
1	22W61A0201	BARNANA TARAKESWARA	P	P	P	P	P	P	P	A	P	P	P
2	22W61A0202	DUDDU MOHANA RAO	P	P	P	P	P	P	P	A	P	P	P
3	22W61A0203	DUNGA GANESH	P	P	P	P	P	A	P	P	P	P	P
4	22W61A0204	DUPPALA PURNACHANDRA	P	P	P	P	P	P	P	P	P	P	P
5	22W61A0205	GULIVENDALA VENKATA	P	P	P	P	A	P	P	P	P	P	P
6	22W61A0206	KANUSU SURENDRA	P	P	P	P	P	P	A	P	P	P	P
7	22W61A0207	KOLLA GAYATRI	P	A	P	P	A	P	P	P	P	P	P
8	22W61A0208	KONCHADA RAJU	P	P	P	P	P	P	A	P	A	P	P
9	22W61A0209	PIRIYA ABHIVARUN	P	P	P	P	P	P	P	A	P	P	P
10	22W61A0210	POGIRI SRAVANI	P	P	P	P	P	P	A	P	P	P	P
11	22W61A0402	ANIPINDI DINESH	P	P	A	P	A	P	P	P	P	P	P
12	22W61A0403	ANNEPU PAVAN	P	P	P	P	P	P	P	A	P	P	P
13	22W61A0404	BAMMIDI AVINASH	P	P	P	P	P	P	P	A	P	P	P
14	22W61A0407	BODDA AJAY	P	A	P	P	P	P	P	P	P	P	P
15	22W61A0408	BONGU	P	P	A	P	P	P	P	P	P	A	P
16	22W61A0409	DAKA SAMEERA	P	P	P	A	P	P	P	P	P	P	P
17	22W61A0410	DOKKA KOTESWARA RAO	P	P	P	P	P	P	P	A	P	P	P
18	22W61A0411	DONTUKURTHU YASODHA	P	P	P	P	A	P	P	P	P	P	P
19	22W61A0412	GEDELA KIRAN	P	P	P	P	P	P	A	P	P	P	P
20	22W61A0413	GEDELA PRATAP	P	P	P	A	P	A	P	P	A	P	A
21	22W61A0414	GONDU GAYATHRI	P	P	P	P	P	P	A	P	P	P	P
22	22W61A0415	GURUGUBELLI DIVYA	A	P	P	A	P	P	P	P	P	P	P
23	22W61A0416	JARUGULLA	P	P	P	P	A	A	P	P	P	P	P
24	22W61A0417	JOGI KIRAN	P	A	P	P	P	P	P	P	P	A	P
25	22W61A0418	KALIVARAPU SRAVANI	P	P	P	P	A	P	P	P	P	P	P
26	22W61A0419	KANDHI ERRAMNAIDU	P	P	P	P	P	P	P	A	A	P	P
27	22W61A0420	KARRI PAVANI	P	P	P	P	P	P	P	A	P	P	P
28	22W61A0421	KEMBURU NAVEEN	P	P	A	P	P	P	P	P	P	P	A
29	22W61A0422	KORNU MANOJ	P	P	P	P	A	P	P	P	P	P	P
30	22W61A0423	KOTTAVALASA DHANA	P	P	P	P	P	P	P	A	P	P	P
31	22W61A0424	LINGIBHERI MADHAVI	P	P	P	P	P	P	P	A	P	P	P
32	22W61A0425	MADDILA NARENDRA	P	P	P	A	P	P	P	P	P	P	P
33	22W61A0426	MURAPAKA RAJESH	P	P	P	P	P	P	P	A	P	P	P
34	22W61A0427	MYLAPILLI NITISH SAI	P	P	P	P	A	P	P	P	P	P	P



S.No	Roll No	Name of The Student	01 8/05	02 9/05	03 10/05	04 11/05	05 12/05	06 13/05	07 15/05	08 16/05	09 17/05	10 18/05	11 19/05
35	22W61A0428	NAGARAPU VENKATESH	P	P	P	P	P	P	P	P	P	P	P
36	22W61A0429	NAVIRI HARINI	P	P	P	P	P	A	P	P	P	P	P
37	22W61A0430	PALISETTI SATISH	P	P	P	P	P	P	P	P	P	A	P
38	22W61A0431	PANDRANKI GANESH	P	P	P	P	P	A	P	P	P	P	P
39	22W61A0432	PANGA HEMANTHU	A	P	P	P	P	P	P	P	P	P	P
40	22W61A0433	PONNADA VENKATA SRI	P	P	P	P	P	P	P	P	P	P	A
41	22W61A0434	POTNURU RATNA SRI	P	P	P	P	P	A	P	P	P	P	P
42	22W61A0435	PURIJALA VENKATA	P	P	P	P	P	P	P	P	P	P	P
43	22W61A0436	RAVADA BUTCHI	P	P	P	P	P	P	P	P	P	P	P
44	22W61A0437	REDDI LIKHITHA	P	P	P	P	P	P	P	P	A	P	P
45	22W61A0438	REDDI NITEESHA	P	A	P	P	P	P	P	P	P	P	P
46	22W61A0439	SADAGANA TEJESWARI	P	P	P	P	P	P	P	P	P	P	P
47	22W61A0440	SASUPALLI PUSHYAMI	P	P	P	P	P	P	P	A	P	P	P
48	22W61A0441	SINGUPURAPU BHAVANI	P	P	P	P	P	P	P	P	P	P	P
49	22W61A0442	TULAGAPU SANTI	P	P	P	P	P	P	P	P	P	P	P
50	22W61A0443	UBBISETTI NAGABABU	P	P	P	P	A	P	P	P	P	P	P
51	22W61A0445	VANDANA SAMRUTHA	A	P	P	P	P	P	P	P	P	A	P
52	22W61A0446	VANJANGI SAI KRISHNA	P	P	P	P	P	P	P	P	P	P	P
53	22W61A0447	VARANASI SIRISHA	P	P	P	P	P	A	P	P	P	P	P
54	22W61A0448	AATLA AJAY KUMAR	P	P	P	P	P	P	P	P	P	P	P
55	22W61A0449	BEHARA MANOHAR SAI	P	A	P	P	P	P	P	P	P	P	P
56	22W61A0450	BEHARA YASWANTH SAI	P	P	P	P	P	P	P	P	P	P	P
57	22W61A0451	VALLE BHAVANI	P	P	P	A	P	P	P	P	P	P	P
58	22W61A6101	ABOTHULA KEERTHANA	P	P	A	P	P	P	P	P	P	P	P
59	22W61A6102	ANDHAVARAPU	A	P	P	P	P	P	P	P	P	A	P
60	22W61A6103	ATTADA JASWANTH	P	P	P	P	P	P	P	A	P	P	P
61	22W61A6104	BEHARA JAYENDRA	P	P	P	P	P	P	P	P	P	P	P
62	22W61A6105	BEVARA RAJASEKHAR	P	P	P	P	P	P	P	P	A	P	P
63	22W61A6106	BIRLANGI KUMAR	P	P	P	P	P	P	P	P	P	P	P
64	22W61A6107	BONAM TEJESWARI	P	P	P	P	P	P	P	P	P	P	A
65	22W61A6108	BONTHA ARAVIND	P	P	P	A	A	P	P	P	P	P	P
66	22W61A6109	CHALLA SANTHOSH	A	P	P	P	P	P	P	P	P	P	P
67	22W61A6110	CHIPURU JOGENDRA	P	P	P	P	P	P	P	P	P	P	P
68	22W61A6111	CHODAVARAPU BHAVANI	P	P	P	P	P	A	P	P	P	P	P
69	22W61A6112	DAMARASINGU	P	P	P	P	P	P	P	P	P	P	P
70	22W61A6113	DOLA MANIKANTA	P	P	A	P	P	P	P	A	P	P	P
71	22W61A6114	GADIDESI MOHANARAO	P	P	P	P	P	P	P	P	P	P	P
72	22W61A6115	GORLE MOUNIKA	P	P	P	P	P	P	P	P	P	A	P
73	22W61A6116	GUDIPADRA PREETHI	P	P	P	P	P	P	P	P	P	P	P
74	22W61A6117	GUDLA MOUSMI	P	A	P	P	P	P	P	P	P	P	A
75	22W61A6118	JADDU PAVAN KUMAR	P	P	P	P	P	P	P	A	P	P	P
76	22W61A6119	KANTUBOTHU ARAVIND	P	P	P	P	P	P	P	P	P	P	P
77	22W61A6120	KETHALA SANJAY	A	P	P	P	P	P	P	P	P	P	P
78	22W61A6121	KIMIDI HARIKRISHNA	P	P	P	A	P	P	P	P	P	P	P
79	22W61A6122	KORADA SRIJA	P	P	P	P	P	P	P	P	P	P	P
80	22W61A6124	MAMIDI UDAYA KIRAN	P	P	P	P	A	A	P	P	P	P	P
81	22W61A6125	MANDALA BHASHITHA	P	P	P	P	P	P	P	P	P	P	P
82	22W61A6126	MANDALA PALLAVI	P	P	P	P	A	P	P	P	P	P	P



S.No	Roll No	Name of The Student	01 8/5	02 9/5	03 10/5	04 11/5	05 12/5	06 13/5	07 15/5	08 16/5	09 17/5	10 18/5	11 19/5	12
83	22W61A6127	MEDIMI TARUN	P	P	P	P	P	P	P	P	P	P	P	
84	22W61A6128	MOLLI KOTESWARARAO	P	P	P	P	P	P	P	P	P	A	P	
85	22W61A6129	NAMBURI PHANINDRA	P	P	P	P	P	P	P	P	P	P	P	
86	22W61A6131	PAILA SAIKUMAR	P	P	P	P	P	P	P	P	P	P	P	
87	22W61A6132	PANCHADI KOMALA	P	P	P	A	P	P	P	P	P	P	P	
88	22W61A6133	PINNINTI JASMITHA	P	P	P	P	P	P	A	P	P	P	P	
89	22W61A6134	PODUGU	P	P	A	P	P	P	P	P	P	P	P	
90	22W61A6135	PYDI JHANSI	P	P	P	P	P	P	P	P	A	P	P	
91	22W61A6136	RAKOTI VARA PRASAD	P	P	P	P	P	P	P	P	P	A	P	
92	22W61A6137	REDDY ANITA	P	P	P	P	A	P	P	P	P	P	P	
93	22W61A6138	SANAPALA VINOD	P	P	P	P	P	P	P	P	P	P	P	
94	22W61A6139	SEEPANA CHINNI KRISHNA	P	P	P	P	P	A	P	P	A	P	P	
95	22W61A6140	SEERAPU KAVYA	P	P	P	P	P	P	P	P	P	P	P	
96	22W61A6141	SURU DURGA VENKATA	P	P	P	P	P	P	P	P	P	P	P	
97	22W61A6143	TANGI GNANA DEEPTHI	P	P	P	A	P	P	P	P	P	P	P	
98	22W61A6145	VALUROUTHU ANITHA	P	P	P	P	P	P	P	P	P	P	A	
99	22W61A6146	VANKAYALA LAXMI	P	A	P	P	P	P	P	P	P	P	P	
100	22W61A6148	YAMPALLA AJAY KUMAR	A	P	P	P	P	P	P	P	P	A	P	
101	22W61A6149	KOTA YASWANTH	P	P	P	P	P	P	P	P	P	P	P	
102	22W61A6150	TALAGANA JAYAKRISHNA	P	P	P	P	P	P	P	P	P	P	P	
Signature :														

  
Program Co-ordinator





# SRI SIVANI COLLEGE OF ENGINEERING

(Under the Management of Sri Sivani Educational Society, Srikakulam)  
(Approved by AICTE, New Delhi and Affiliated to JNTUGV, Vizianagaram-CC-W6,  
UGC Recognition under 2(f) & 12(B), ISO 9001:2015 Certified)  
NH-16, Chilakapalem Jn., Srikakulam Dist -532410

## DEPARTMENT OF HUMANITIES & BASIC SCIENCES

Academic year: 2022-23

Date: 23-05-2023

### PROGRAM REPORT

**Name of the program** : A Two Week Add-On Program on “**Statistical Distributions**”.

**Duration of the program** : 08-05-2023 to 19-05-2023

**Details of Resource Person** : Mr.K.Kotibabu,  
Assistant Professor,  
Dept. of H&Bs,  
Sri Sivani College of Engineering  
Kotibabu242@gmail.com  
9440561252

**Details of Program co ordinator** : Mrs .R.Nagamani, M.Sc,  
Asst Professor,  
Dept. of H&Bs,  
Sri Sivani College of Engineering  
rapaka.nagamani11@gmail.com  
8074315077

#### **Objectives of the program:**

- Understand how the sampling app in stetchrunch works and why we use it.
- Understand that the distribution of the data can have many different shapes. Sample size can't change the shape.
- The spread of the sample mean is called the standard error and can be calculated with the formula.
- You will need to use this app latter, to check the reliability of the data analysis.



**Topics covered:**

1. Conditional Probability.
2. Bayes theorem.
3. Binomial Distribution.
4. Poisson distribution.
5. Normal Distribution.
6. Properties.
7. Moment generating function.
8. Sampling Distributions.

**Outcomes of the program:**

On completion of the course, student should be able to:

1. Be able to calculate probabilities for averages based on the average being close to normally distributed.
2. Be able to assess in the sample average is close to normal based on the histogram of the data and the sample size.
3. Be able to do “sum” type calculations.

**Number of participants : 102**

  
**Program Co-ordinator**





# SRI SIVANI COLLEGE OF ENGINEERING

(Under the Management of Sri Sivani Educational Society, Srikakulam)  
(Approved by AICTE, New Delhi and Affiliated to JNTUV, Vizianagaram-CC-W6,  
UGC Recognition under 2(f) & 12(B), ISO 9001:2015 Certified)  
NH-16, CHILAKAPALEM, SRIKAKULAM, A.P.-532410

## Participation Certificate

This is certifying that Mr./Ms Kornu Manoj bearing

Roll No. 22WG1A042 Of I Year II semester has completed A Two week Add-On program on  
"Statistical Distributions" during the Period **08-05-2022 to 19-05-2023** organized by Department of Humanities &  
Basic sciences.

  
**Co-ordinator**

  
**HOD**

  
**Principal**



# SRI SIVANI COLLEGE OF ENGINEERING

(Under the Management of Sri Sivani Educational Society, Srikakulam)  
(Approved by AICTE, New Delhi and Affiliated to JNTUV, Vizianagaram-CC-W6,  
UGC Recognition under 2(f) & 12(B), ISO 9001:2015 Certified)  
NH-16, CHILAKAPALEM, SRIKAKULAM, A.P.-532410

## Participation Certificate

This is certifying that Mr./Ms Gr. Bhavani Shankar bearing

Roll No. 18WG1A0516 Of I Year II semester has completed A Two week Add-On program on  
“Statistical Distributions” during the Period 08-05-2022 to 19-05-2023 organized by Department of Humanities &  
Basic sciences.

  
**Co-ordinator**

  
**HOD**

  
**Principal**





# SRI SIVANI COLLEGE OF ENGINEERING

(Under the Management of Sri Sivani Educational Society, Srikakulam)  
(Approved by AICTE, New Delhi and Affiliated to JNTUV, Vizianagaram-CC-W6,  
UGC Recognition under 2(f) & 12(B), ISO 9001:2015 Certified)  
NH-16, CHILAKAPALEM, SRIKAKULAM, A.P.-532410

## Participation Certificate

This is certifying that Mr./Ms Pogiri. Manojkumar bearing

Roll No. 18W61A0547 Of I Year II semester has completed A Two week Add-On program on  
"Statistical Distributions" during the Period **08-05-2022 to 19-05-2023** organized by Department of Humanities &  
Basic sciences.

  
**Co-ordinator**

  
**HOD**

  
**Principal**



# SRI SIVANI COLLEGE OF ENGINEERING

(Under the Management of Sri Sivani Educational Society, Srikakulam)  
(Approved by AICTE, New Delhi and Affiliated to JNTUV, Vizianagaram-CC-W6,  
UGC Recognition under 2(f) & 12(B), ISO 9001:2015 Certified)  
NH-16, CHILAKAPALEM, SRIKAKULAM, A.P.-532410

## Participation Certificate

This is certifying that Mr./Ms Reddy. Anitha bearing

Roll No. 22W6/AG/37 Of I Year II semester has completed A Two week Add-On program on  
“Statistical Distributions” during the Period **08-05-2022** to **19-05-2023** organized by Department of Humanities &  
Basic sciences.

  
**Co-ordinator**

  
**HOD**

  
**Principal**